



Swachh Bharat Mission (Grameen)

Phase II Operational Guidelines

May 2020

Swachh Bharat Mission (Grameen)

Phase II Operational Guidelines

May 2020

गजेन्द्र सिंह शेखावत
Gajendra Singh Shekhawat



जल शक्ति मंत्री
भारत सरकार
Minister for Jal Shakti
Government of India

Message

The Swachh Bharat Mission (Grameen), arguably the world's largest behaviour change programme, has been a source of inspiration to countries around the world. It was, indeed, a social revolution that transformed the lives of our people, bringing significant improvement in terms of economic, environmental, health and social benefits, and enhanced the safety and dignity of our women.

With all villages and States in the country having declared themselves Open Defecation Free (ODF), it is time now for us to sustain the gains made so that all villages in the country become ODF Plus during Phase II of Swachh Bharat Mission Grameen, i.e. that all villages sustain their ODF status and ensure effective management of solid and liquid waste.

These Operational Guidelines are intended to provide specific guidance to managers at State, District and Gram Panchayat levels. Various components of ODF Plus – sustainability of ODF status, bio-degradable waste management, plastic waste management, greywater management, faecal sludge management, and modalities for convergence with other schemes have been outlined extensively. Implementers need to use them for community-based interventions to facilitate hygiene promotion and sanitation in all areas.

The Phase II of Swachh Bharat Mission Grameen will continue to generate employment and provide impetus to the rural economy through construction of household toilets and community sanitary complexes, as well as infrastructure for Solid and Liquid Waste Management such as compost pits, soak pits, waste stabilisation ponds, material recovery facilities, etc.

I extend my gratitude to all who have contributed to the formulation of these guidelines and shared their valuable experiences and suggestions.

I sincerely hope that implementers will exhibit the same enthusiasm and creativity as they did in the first phase of the campaign and make it a movement of the people, by the people and for the people.

(Gajendra Singh Shekhawat)

Office : 210, Shram Shakti Bhawan, Rafi Marg, New Delhi-110 001
Tel: No. (011) 23711780, 23714663, 23714200, Fax : (011) 23710804
E-mail : minister-mowr@nic.in

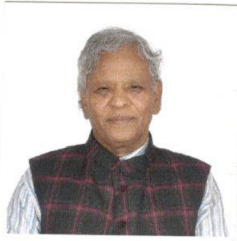

रतन लाल कटारिया
RATTAN LAL KATARIA



जल शक्ति और सामाजिक न्याय
एवं अधिकारिता राज्य मंत्री
भारत सरकार, नई दिल्ली

Minister of State for Jal Shakti and
Social Justice & Empowerment
Government of India, New Delhi

May, 2020

Message

The importance of ODF Sustainability and Solid and Liquid Waste Management cannot be overemphasized. While ODF Sustainability helps us preserve the gains we have made in the first phase of the Swachh Bharat Mission Grameen (SBM-G), proper waste management can contribute significantly to the environment and human health. With a view of keeping our villages clean and open defecation free, and ensuring Solid and Liquid Waste Management in all villages of the country, the Government of India is implementing Phase II of the SBM-G.

Also implemented in mission mode like Phase 1, the second phase of the SBM-G will be monitored on the basis of the outcome in key areas viz. ODF sustainability and improvement in visual cleanliness of villages – minimal litter and minimal stagnant water. Intensive efforts will also be made to ensure that all households continue to have access to toilets and that no one is left behind.

As we embark on the Phase II of the SBM-G, I wish implementers at State, District and Panchayat level success in their endeavours, and I hope that their achievements will have a lasting and positive impact on our rural population and the country at large.

Jai Hind

(Rattan Lal Kataria)

215, Shram Shakti Bhawan, Rafi Marg, New Delhi – 110 001
Tel. No. (011) 23708419, 23718759, Fax: (011) 23354496



परमेश्वरन अय्यर
Parameswaran Iyer



सत्यमेव जयते



Secretary

Government of India

Ministry of Jal Shakti

Department of Drinking Water & Sanitation

1st Floor, Pt Dindayal Antodaya Bhawan, N D-110003

Tel: 24361011, 24362715,

e-Mail: param.iyer@gov.in

Message

The Swachh Bharat Mission was launched on 2nd October 2014 by the Hon'ble Prime Minister, Shri Narendra Modi, with an aim to achieve an Open Defecation Free India by 2nd October 2019, a tribute to Mahatma Gandhi on his 150th birth anniversary.

The world's largest behaviour change programme, the Swachh Bharat Mission (Grameen) [SBM(G)] achieved the seemingly impossible task by transforming itself into a *Janandolan* (people's movement), with 130 crore people from all spheres of life contributing to make the programme a success. As a result, the rural sanitation coverage increased from 39 per cent in 2014 to 100 per cent in 2019 with over 10.28 crore toilets built across 36 States/UTs. As of 2nd October 2019, all districts across India had declared themselves Open Defecation Free (ODF).

The impact of the SBM(G) has been articulated by various global agencies, estimating significant economic, environmental, health and social impacts. Having achieved the important milestone of an ODF India, the work on sanitation and the behaviour change campaign continues in order to sustain the gains made under the programme during the last five years (2014-2019), to ensure that no one is left behind, and to transform all villages from ODF to ODF Plus.

The Government of India, in February 2020, approved the Phase-II of the SBM(G) with a total outlay of Rs. 1,40,881 crores to focus on the sustainability of ODF status and Solid and Liquid Waste Management (SLWM). SBM(G) Phase II is planned to be a novel model of convergence between different verticals of financing and various schemes of the Central and State Governments. Apart from budgetary allocations from the Department of Drinking Water and Sanitation and the corresponding State share, remaining funds will be dovetailed from the 15th Finance Commission grants to Rural Local Bodies, MGNREGS, CSR funds, and revenue generation models, etc., particularly for SLWM.

SBM(G) Phase-II will be implemented in mission mode from 2020-21 to 2024-25. The operational guidelines for Phase II have been formulated in this booklet. These guidelines are advisory in nature and may be adapted as per local requirements and conditions.

We hope that these guidelines prove to be a useful tool for all State and District teams, helping them to plan and strengthen their strategy, as well as enhance the implementation.

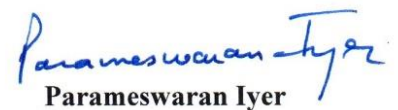
Parameswaran Iyer

Arun Baroka, IAS
Additional Secretary



Ministry of Jal Shakti
Department of Drinking Water & Sanitation
Pt. Deendayal Antodaya Bhawan
CGO Complex, Lodhi Road
New Delhi -110003

Introduction

This booklet provides operational guidelines for the implementation of the Phase-II of Swachh Bharat Mission in rural (ग्रामीण- *grameen*) areas of India, which have been formulated based on Union Governments' approval of Phase-II of the Swachh Bharat Mission (Grameen) [SBM(G)] in February 2020.

The SBM(G) was launched on 2nd October 2014 by the Hon'ble Prime Minister, Shri Narendra Modi to ensure cleanliness in India and make it Open Defecation Free (ODF). Said to be the world's largest behaviour change programme, it achieved the seemingly impossible task by generating a people's movement at the grassroots. All stakeholders worked together from 2014 to 2019 and in a time bound manner ensured that, as on 2nd October 2019 all districts across India, declared themselves as ODF.

Having achieved the milestone of an ODF India in a time bound manner in the last five years from 2014 to 2019, the work on sanitation and the behaviour change campaign has to continue to sustain the gains made under the programme and also to ensure no one is left behind and the overall cleanliness (सम्पूर्ण स्वच्छता - Sampurn Swachhata) in villages as well. To pursue these objectives, its planning had begun sometime back - in the beginning of the year 2019. Extensive discussions with all States/UTs and other stakeholders were held. Feedback from evaluation of the programme based on three rounds of National Annual Rural Sanitation Survey [NARSS], umpteen number of video conferences with States and districts and also interactions with general public and field functionaries during field visits of our officers and consultants in the Ministry was useful. Extensive discussions were held with other ministries in GoI and also NITI Aayog and Ministry of Finance and the result was that the Government of India, in February 2020, approved Phase-II of the SBM(G) with a total outlay of Rs. 1,40,881 crores to focus on the sustainability of ODF status and Solid and Liquid Waste Management (SLWM). Timely release of report of XV Finance Commission for the year 2020-21 on the 1st Feb 2020 was helpful in providing the much needed and asked for tied grants (tied for the first time) for sanitation to Rural Local Bodies.

SBM(G) Phase-II is planned to be a novel model of convergence between different verticals of financing and various schemes of Central and State Governments. The programme will be implemented in mission mode from 2020-21 to 2024-25. The operational guidelines for Phase-II have been formulated in this booklet. These guidelines are advisory in nature and may be adapted as per local requirements and conditions.

These guidelines are not the work of any single individual. It has been the combined team work based on inputs from States/UTs and all those in the Ministry in SBM Division, who have worked tirelessly and contributed immensely in the preparation of the Cabinet note and also the operational guidelines.

We hope this will be a useful tool for all State and District teams, helping to plan and strengthen their strategy as well as enhance the implementation experience.

Arun Baroka

CONTENTS

ABBREVIATIONS	9
1 PREFACE	12
2 PREVIOUS PROGRAMMES	14
3 SWACHH BHARAT MISSION (2014-2019)	15
4 SWACHH BHARAT MISSION (GRAMEEN) PHASE II (2020-21 – 2024-25)	16
4.1 OBJECTIVE	17
4.2 GUIDING PRINCIPLES FOR IMPLEMENTATION	18
5 COMPONENTS OF SBMG PHASE II	20
5.1 CONSTRUCTION OF INDIVIDUAL HOUSEHOLD LATRINES	20
5.2 RETROFITTING OF TOILETS	22
5.3 CONSTRUCTION OF COMMUNITY SANITARY COMPLEXES (CSCs)	22
5.4 WORKS FOR SOLID WASTE MANAGEMENT	23
5.4.1 Bio-degradable waste management	23
5.4.1.1 Composting	23
A. Household level Compost pit	23
B. Community level Compost pit	24
5.4.1.2 GOBAR-dhan (Galvanizing Organic Bio-Agro Resources–dhan)	25
5.4.2 Plastic Waste management	25
5.5 WORKS FOR LIQUID WASTE MANAGEMENT	27
5.5.1 Greywater Management	27
5.6 FAECAL SLUDGE MANAGEMENT	28
6 INFORMATION, EDUCATION AND COMMUNICATION (IEC)	30
6.1 ROLE OF STATES FOR IEC	31
6.2 ROLE OF DISTRICTS FOR IEC	32
6.3 IEC CHANNELS AVAILABLE FOR USE BY STATES, DISTRICTS AND GPs	33
6.4 KEY IEC MESSAGES FOR ODF PLUS	34
7 CAPACITY BUILDING	36
7.1 TRAINING AND ORIENTATION OF ALL STAKEHOLDERS	36
7.2 SWACHHAGRAHIS	38
7.2.1 Role of Swachhagrahis	38
7.2.2 Incentives for Swachhagrahis	38
8 INSTITUTIONAL ARRANGEMENTS	39
8.1 NATIONAL SCHEME SANCTIONING COMMITTEE	39
8.2 STATE WATER AND SANITATION MISSION	39
8.3 APEX COMMITTEE	40
8.4 STATE MISSION OR SSBMG	40
8.5 DISTRICT SWACHH BHARAT MISSION	41
8.6 BLOCK WATER AND SANITATION COMMITTEE	43
8.7 GRAM PANCHAYAT / VILLAGE WATER AND SANITATION COMMITTEE	44
9 ROLE OF PANCHAYATI RAJ INSTITUTIONS	45

9.1	PLANNING	45
9.2	FUND FLOW	45
9.3	COORDINATION	46
9.4	MONITORING	46
10	ROLE OF COMMUNITY BASED ORGANISATIONS / NON GOVERNMENTAL ORGANISATIONS / SELF HELP GROUPS / SUPPORT ORGANISATIONS	47
10.1	RURAL SANITARY MARTS	47
11	MARKET LINKED SLWM INTERVENTIONS	48
12	CORPORATE SOCIAL RESPONSIBILITY	50
13	RESEARCH & DEVELOPMENT	52
14	PLANNING FOR SBMG PHASE II	54
14.1	VILLAGE ACTION PLAN	54
14.2	DISTRICT SWACHHATA PLAN	55
14.3	STATE PLANNING	56
14.3.1	Project Implementation Plan (PIP)	56
14.3.2	Annual Implementation Plan (AIP)	56
15	FINANCIAL PLANNING AND PROGRAMME FUNDING	58
15.1	PROGRAMME FUNDING PROVISIONS IN SBMG PHASE II	59
15.2	FINANCIAL PROVISIONS EXPLAINED	60
16	RELEASE OF FUNDS	63
16.1	RELEASE FROM CENTRE TO STATE LEVEL IMPLEMENTING BODY	63
16.1.1	Release of 1st Installment	65
16.1.2	Release of 2nd installment	65
16.2	RELEASE OF ADDITIONAL FUNDS TO INCENTIVIZE BETTER PERFORMING STATES	67
16.3	INTEREST EARNED ON FUNDS RELEASED	67
17	MONITORING & EVALUATION	68
17.1	OUTPUT OUTCOME MONITORING FRAMEWORK	69
17.2	INTEGRATED MANAGEMENT INFORMATION SYSTEM	70
17.3	BASELINE SURVEY	70
17.4	GEOTAGGING OF ASSETS	70
17.5	DECLARATION AND VERIFICATION OF ODF PLUS VILLAGES	71
17.6	ANNUAL MONITORING THROUGH 'SWACHH SURVEKSHAN GRAMEEN - SSG'	72
17.7	SOCIAL AUDIT	72
17.8	PROGRAMME EVALUATION	72
18	ANNUAL AUDIT	73

ANNEXURES

ANNEXURE – I: Technological details for IHHLs and CSCs

ANNEXURE – II: Technology and management options for Bio-degradable waste

ANNEXURE – III: Guidelines and technology options for GOBAR-dhan

ANNEXURE – IV: Plastic waste management options in Rural areas

ANNEXURE – V: Technology and management options for Greywater management

ANNEXURE – VI: Faecal sludge management options in Rural areas

ANNEXURE – VII: Recommended activities for Swachhagrahis and incentive structure

ANNEXURE – VIII: Indicative list of sanitation activities and suggestive convergence matrix

ANNEXURE – IX: Annual Audit Reports formats

ANNEXURE – X: Utilization Certificate format

ANNEXURE – XI: Gram Panchayat ODF Plus declaration certificate

ANNEXURE – XII: ODF Plus verification Protocol and Format

ANNEXURE – XIII: District ODF Plus verification certificate

ANNEXURE – XIV: Diversion of forest land for non-forestry purposes - Construction of community toilet for the benefit of the people

ABBREVIATIONS

AIP	Annual Implementation Plan
AIR	All India Radio
ANM	Auxiliary Nurse Midwife
APL	Above Poverty Line
ASHA	Accredited Social Health Activist
AWW	Anganwadi Worker
BCC	Behaviour Change Communication
BDO	Block Development Officer
BPL	Below Poverty Line
BWSC	Block Water and Sanitation Committee
BSO	Block Sanitation Officer
CAS	Community Approaches to Sanitation
CBO	Community-Based Organisation
CLF	Cluster Level Federation
CRSP	Central Rural Sanitation Programme
CSC	Community Sanitary Complex
CSR	Corporate Social Responsibility
DDWS	Department of Drinking Water and Sanitation
DAVP	Directorate of Advertising & Visual Publicity
DD	Doordarshan
DRDA	District Rural Development Agency
DSBM	District Swachh Bharat Mission
DTMU	District Training Management Unit
DWSC	District Water and Sanitation Committee
DWSM	District Water and Sanitation Mission
FSM	Faecal Sludge Management
FSTP	Faecal Sludge Treatment Plant
FSMS	Faecal Sludge Management System
GOI	Government of India
GP	Gram Panchayat
GOBAR-DHAN	Galvanizing Organic Bio-Agro Resources Dhan
HRD	Human Resource Development
ICDS	Integrated Child Development Scheme
IEC	Information, Education and Communication
IHHL	Individual Household Latrine
IMIS	Integrated Management Information System
IPC	Interpersonal Communication
JJM	Jal Jeevan Mission
JMP	Joint Monitoring Program
KVK	Krishi Vigyan Kendra
LWM	Liquid Waste Management
M&E	Monitoring & Evaluation
MHM	Menstrual Hygiene Management

MIS	Management Information System
MLALADS	Member of Legislative Assembly Local Area Development Scheme
MNREGS	Mahatma Gandhi National Rural Employment Guarantee Scheme
MOJS	Ministry of Jal Shakti
MPLADS	Member of Parliament Local Area Development Scheme
NABARD	National Bank for Agriculture and Rural Development
NARSS	National Annual Rural Sanitation Survey
NFDC	National Film Development Corporation
NGO	Non-Governmental Organisation
NIC	National Informatics Centre
NNBOMP	New National Biogas and Organic Manure Programme
NRC	National Resource Centre
NRDWP	National Rural Drinking Water Program
NRHM	National Rural Health Mission
NRLM	National Rural Livelihood Mission
NSSC	National Scheme Sanctioning Committee
NSSO	National Sample Survey Organisation
ODF	Open Defecation Free
ODF-S	Open Defecation Free Sustainability
ODF Plus	Open Defecation Free Plus
O&M	Operation and Maintenance
PAC	Plan Approval Committee
PC	Production Centre
PFMS	Public Financial Management System
PHC	Public Health Centre
PHED	Public Health Engineering Department
PIP	Project Implementation Plan
PMAY	Pradhan Mantri Awas Yojana
PMGSY	Pradhan Mantri Gram Sadak Yojana
PPP	Public Private Partnership
PR	Panchayati Raj
PRA	Participatory Rural Appraisal
PRI	Panchayati Raj Institution
PSU	Public Sector Undertakings
PTA	Parent Teachers Association
PWMC	Plastic Waste Management Centre
R&D	Research and Development
RDAC	Research and Development Advisory Committee
RSM	Rural Sanitary Mart
SAP	Swachhata Action Plan
SATAT	Sustainable Alternative Towards Affordable Transportation
BCC	Behaviour Change Communication
SBK	Swachh Bharat Kosh
SBMG	Swachh Bharat Mission (Grameen)
SHG	Self Help Group
SLSSC	State Level Scheme Sanctioning Committee

SLTS	School Led Total Sanitation
SLWM	Solid and Liquid Waste Management
SO	Support Organisation
SPMU	State Project Monitoring Unit
STMU	State Training Management Unit
SSA	Sarva Shiksha Abhiyan
SSBM	State Swachh Bharat Mission
SSG	Swachh Survekshan Grameen
SGSY	Swaranjayanti Gram Swarozgar Yojana
STP	Sewage Treatment Plant
SWSC	State Water and Sanitation Committee
SWSM	State Water and Sanitation Mission
SWM	Solid waste management
TSC	Total Sanitation Campaign
VAP	Village Action Plan
VO	Village Organisation
VWSC	Village Water and Sanitation Committee
WASH	Water, Sanitation and Hygiene
WSP	Waste Stabilisation Pond
WSSO	Water and Sanitation Support Organisation
ZP	Zila Parishad



1

PREFACE



The Swachh Bharat Mission was launched on 2nd October 2014 by the Hon'ble Prime Minister, Shri Narendra Modi, with an aim to achieve a clean India by 2nd October 2019, a tribute to Mahatma Gandhi on his 150th birth anniversary. Swachh Bharat Mission aimed to provide safety, security and convenience, especially for women and children, by eliminating the shameful habit of open defecation across the country.

Said to be the world's largest behaviour change programme, the Swachh Bharat Mission (Grameen) [SBMG] achieved the seemingly impossible task by generating a people's movement at the grassroots. As a result, the rural sanitation coverage increased from 39 per cent in 2014 to 100 per cent in 2019 with over 10.28 crore toilets built across 36 States/UTs. As of 2nd October 2019, all districts across India had declared themselves ODF.

The success of the campaign is attributed to the 4Ps - political leadership, public financing, partnerships and people's participation - with the Prime Minister leading it from the front with the resolve to eradicate the practice of open defecation in five years. It was a *janandolan* (people's movement) in the truest sense with 130 crore people from all spheres of life contributing to making the programme a success, of a magnitude that few could have imagined.

The impact of the SBMG has been articulated by various global agencies, estimating significant economic, environmental and health impacts, contributing to the health of children and empowerment of women, in particular. Having achieved the important milestone of an ODF India, the work on sanitation and the behaviour change campaign continues in order to sustain the gains made under the programme during the last five years (2014-

2019), to improve overall cleanliness in villages, and to ensure that no one is left behind.

The Government of India, in February 2020, approved Phase-II of the SBMG with a total outlay of Rs. 1,40,881 crores to focus on the sustainability of ODF status and Solid and Liquid Waste Management (SLWM). SBMG Phase II is planned to be a novel model of convergence between different verticals of financing and various schemes of Central and State Governments. Apart from budgetary allocations from Department of Drinking Water and Sanitation and the corresponding State share, remaining funds will be dovetailed from 15th Finance Commission grants to Rural Local Bodies, MGNREGS, CSR funds, and revenue generation models, etc., particularly for SLWM.

SBMG Phase-II will be implemented in mission mode

from 2020-21 to 2024-25. The operational guidelines for Phase II have been formulated in this booklet. These guidelines are advisory in nature and may be adapted as per local requirements and conditions.

We hope they prove to be a useful tool for all State and District teams, helping to plan and strengthen their strategy as well as enhance the implementation experience.

The successful implementation of Phase I of SBMG was lined with narratives of courage, tireless efforts, innovation and more – by individuals, communities and district teams to make ODF behaviour an accepted norm. It is hoped to have similar enthusiasm and drive in SBMG Phase II, towards promoting clean villages, hygiene promotion and the health and well-being of our communities, in the spirit of making this a people's movement.

2

PREVIOUS PROGRAMMES



The first sanitation programme for rural India was introduced in 1954 as a part of the First Five Year Plan of the Government of India (GOI). Given that the 1981 Census revealed that rural sanitation coverage was only 1%, a greater emphasis was then given to rural sanitation during the International Decade for Drinking Water and Sanitation (1981-90). The GOI introduced the Central Rural Sanitation Programme (CRSP) in 1986 with the primary objective of improving the quality of life of rural people and to provide privacy and dignity to women. From 1999, a “demand-driven” approach under the “Total Sanitation Campaign” (TSC) was adopted. It emphasized Information, Education and Communication (IEC), Human Resource Development (HRD) and Capacity Development to increase awareness regarding safe sanitation leading to demand generation for sanitary facilities. This enhanced people’s capacity to choose appropriate options through alternate

delivery mechanisms as per their economic condition. Financial incentives were provided to Below Poverty Line (BPL) households for construction and usage of individual household latrines (IHHL), in recognition of their achievements. The ‘Nirmal Bharat Abhiyan’ (NBA), the successor programme of the TSC, was launched from April 1, 2012. The objective was to accelerate the sanitation coverage in the rural community through renewed strategies and saturation approach. NBA worked towards achieving necessary outcomes to create Nirmal Gram Panchayats. Under the NBA, the incentives for IHHLs were enhanced and further support was obtained in convergence with MGNREGS.

While the above mentioned programmes made some progress for the rural sanitation landscape of the country, in the census of 2011, rural sanitation coverage (households with individual latrines) was found to be only 33%.

3

SWACHH BHARAT MISSION (2014-2019)



To significantly accelerate the efforts to achieve universal sanitation, the Prime Minister of India launched the Swachh Bharat Mission on October 2, 2014. The Mission aimed to achieve a Swachh Bharat by October 2, 2019, as a fitting tribute to Mahatma Gandhi on his 150th birth anniversary, by eliminating the practice of open defecation.

The SBM has two sub-Missions, the Swachh Bharat Mission (Grameen) under the Department of Drinking Water and Sanitation (formerly the Ministry of Drinking Water and Sanitation), and the Swachh Bharat Mission (Urban) [SBM(U)] under the Ministry of Housing and Urban Affairs. The overall Mission is coordinated by the Department of Drinking Water and Sanitation. In rural areas, the programme aimed towards achieving Open Defecation Free (ODF) villages and improve the levels of overall cleanliness through SLWM activities.

The SBMG has transformed rural India by manifesting into a janandolan for

sanitation - unlike any other the world has ever seen. Since the launch of the SBMG in 2014, more than 10 crore¹ toilets have been constructed. As a result, by October 2019, all villages across the country, and consequently all 36 States/UTs, had declared themselves ODF.

While the achievement of ODF status has been a major milestone, the Mission continues to work towards the sustainability of ODF gains and to ensure that no one is left behind. The Department of Drinking Water and Sanitation, Ministry of Jal Shakti, also developed a 10-year Rural Sanitation Strategy in September 2019, to achieve and maintain the sustainability of ODF outcomes and Solid and Liquid Waste Management arrangements in rural areas. The 10-year strategy lays down the framework for achieving this long-term vision and is intended to guide and provide the way forward for State Governments, Local Governments, policymakers, implementers and all relevant stakeholders, including the people of rural India.

¹As on 2nd October, 2019.

4

SWACHH BHARAT MISSION (GRAMEEN) PHASE II (2020-21 – 2024-25)



With the key objective of SBMG Phase I attained, the Government of India renewed its commitment to further enhance the sanitation and hygiene status in rural areas with the approval of Phase II of the programme.

SBMG Phase II has been uniquely designed to leverage the capacity of individuals and communities in rural India to create a people's movement to ensure that the ODF status of rural areas is sustained, people continue to practice safe hygienic behaviour and that all villages have solid and liquid waste management arrangements.

SBMG Phase-II will be implemented from 2020-21 to 2024-25 in mission mode with a total estimated outlay of Rs.1,40,881 crores. This will be a novel model of convergence between different verticals of financing and various schemes of Central and State Governments to saturate the sanitation facilities for achieving the ODF Plus villages. Apart from budgetary allocations from DDWS and the corresponding State share, remaining funds will be dovetailed from 15th Finance Commission grants to Rural Local Bodies, MGNREGS and revenue generation models, etc., particularly for SLWM.

4.1 Objective

The key objective of SBMG Phase II is to sustain the ODF status of villages and to improve the levels of cleanliness in rural areas through Solid and Liquid Waste Management activities, making villages ODF Plus.

An ODF Plus village is defined as a village which sustains its Open Defecation Free (ODF) status, ensures solid and liquid waste management and is visually clean.

This includes:

a. ODF-Sustainability That all households in a village, as well as the Primary Schools, Panchayat Ghar and Anganwadi Centre, have access to a toilet and that continued behaviour change communication is ensured in the village through Information, Education and Communication (IEC).

b. Solid Waste Management Effective management of solid waste by at least 80% of households and all public places (including the Primary schools, Panchayat Ghar and Anganwadi centre). This includes the management of bio-degradable waste

from cattle and agricultural activities by individual and community compost pits, and of plastic waste by ensuring an adequate segregation and collection system.

c. Liquid Waste Management

Effective management of liquid waste by at least 80% of households and all public places (including the Primary schools, Panchayat Ghar and Anganwadi Centre). This includes the management of greywater generated from kitchen use and bathing, and storm water, by channels and/or individual and community soak pits, and of any black water due to overflow from septic tanks.

d. Visual cleanliness A village will be classified as visually clean if 80% of households and all public places are observed to have minimal litter and minimal stagnant water, and that there is no accumulation of plastic waste in the form of a dump in the village.

The above objective is to be achieved through continued Behaviour Change Communication and capacity strengthening at all levels.



4.2 Guiding principles for Implementation

1. Ensuring that no one is left behind

The Mission will strive towards providing access to all new households that come up during the project period with safe sanitation facilities, and to any eligible household which may have been left out in its previous phase. Such households will be identified by the GP/District as part of the ODF Plus verification exercise. For those households which do not have individual household latrines due to the lack of space, floating population etc., provision of community managed sanitation complex commonly known as community sanitary complex(CSC) may be made.

2. Community assets for SLWM to be prioritized and financed

While individual assets are encouraged, the programme will prioritize, and provide funding, for the creation of community assets, as far as possible. This is to ensure that every household in the village has access to Solid and Liquid Waste Management facilities. IEC channels will be used to motivate households to construct individual assets, wherever feasible.

3. Utilisation of existing SLWM infrastructure wherever possible

It has been noted that some Solid and Liquid Waste Management infrastructure have been created under various schemes including MGNREGS. The existing infrastructure, where available, will be put to use / rejuvenated / upgraded in convergence with relevant schemes. These could be existing segregation sheds, tricycles, drains and ponds for greywater management, compost pits, soak pits, etc. New infrastructure would be created only, if necessary.

4. SLWM activities related to Reuse to be promoted

Reduction of generation of waste at source is key for waste management. Therefore, the 3R's - Reduce, Reuse and Recycle – are to be promoted. States would intensify efforts to make people aware of the challenges in collection, segregation and management of waste. IEC interventions will be designed to motivate people to create less waste, reuse waste like cow dung for manure, plastic waste for co-processing in industries and greywater for the recharge of groundwater, etc.

5. Convergence with other schemes

The programme is designed for convergent action and the co-financing of assets and services. The programme will be implemented in close coordination and convergence with the Jal Jeevan Mission for greywater management, Finance Commission funds for co-financing of assets, MGNREGS for dovetailing of funds and functionaries, Ministry of Skill Development & Entrepreneurship for skill development of field functionaries, NRLM for involving SHGs as vehicles for BCC, NNBOBP scheme of Ministry of New and Renewable Energy and SATAT Scheme of Ministry of Petroleum & Natural Gas for GOBAR-Dhan projects. States will identify any other schemes at their level and converge with them to ensure attainment of SBMG Phase II objectives.

6. Use of business models/Creating self-sustainable revenue models

It is important that the expertise and resources of the private sector are leveraged for meeting the growing demand for Solid and Liquid Waste Management services. States shall create enabling provisions for the private sector to join the business of delivering effective sanitation services to people in rural areas. States should promote interventions that are based on remunerative models and on principles of cost-sharing, cost recovery and revenue

generation. States may consider support to Self Help Groups (SHGs)/ Village Organisations (VOs) / City-Level Federations (CLFs) and with the approval of Government of India borrowing/interest subvention models, wherever feasible. Business models shall be promoted for the construction and operation and management of Community Sanitary Complexes, GOBAR-dhan projects, and the collection and management of waste including plastic waste and faecal sludge.

7. Operation and maintenance as an obligatory component of planning

Effective and decentralized operation and maintenance of assets shall be the hallmark of SBMG Phase II. All SLWM assets shall be approved only when backed by an effective operation and maintenance plan. Operation and maintenance models could vary from GPs using Finance Commission Funds, taxes, CSR funds to PPP and revenue generation models. States and Districts shall have the flexibility to use models appropriate to the local context for the maintenance of the assets created under the programme.

8. Encouragement of technologies with low operation and maintenance costs States shall promote technologies that are easy to operate and maintain at

low O&M cost. This will ensure that local resources are sufficient to meet the O&M costs.

9. Flexibility to States States will have the flexibility in deciding appropriate implementation mechanism and to choose technologies best suited to the climatic conditions, hydrogeology and topography of the area. This will promote the use of responsive technological options that can be owned, used and operated by communities.

10. Clustering of villages for maximum economic efficiency Wherever necessary and possible, villages from different GPs can be clustered under a single project based on relevant criteria such as topography, contiguity, distance for transportation of waste, time, labour, material, land availability, etc. to achieve economies of scale.

11. Priority to villages on the banks of Ganga and other water bodies States will ensure that villages situated on the banks of Ganga are prioritized for implementation of SLWM interventions. The next priority will be given to the villages on the banks of other prominent water bodies (rivers, lakes, coastal areas, etc).



5

COMPONENTS OF SBMG PHASE II



All States/UTs will develop a detailed implementation strategy and plan based on, but not limited to, the components mentioned below:

5.1 Construction of Individual Household Latrines

Households identified as a new household / left out household, as approved by the district, shall be supported by the Gram Panchayat to construct their Individual Household Latrine. A duly completed IHHL shall consist of i) a sanitary substructure (that safely confines human faeces and eliminates the need for human handling before it is fully decomposed), ii) a super structure, and iii) water storage facility for handwashing and cleaning to ensure that proper hygiene is maintained.

The Mission aims to ensure that all rural families have access to safe toilets and therefore safe technology options are an important component of toilet choice. There are various safe sanitation technologies available such as twin pit, septic tank with soak pit, eco-san, and bio-toilets, among others. While GOI provides flexibility to States

in choosing the right technology depending on topography, ground water level, soil conditions, etc., properly constructed twin-pit toilets are known to have advantages such as being low-cost, easy to build, and have low water consumption. States may develop other safe technologies as well, and States shall disseminate information about available technologies and their costs to the beneficiary to enable him/her to make an informed choice.

All BPL households and identified APL households (SC/ST households, households with physically disabled person, landless labourers with homestead, small and marginal farmers and women headed households) shall be eligible for incentive up to Rs. 12,000 for the construction of one unit of IHHL including for water storage facility for handwashing and cleaning to ensure hygiene. The aim of the incentive is not to provide the full cost of the toilet but to facilitate a positive change in behaviour for people to undertake construction of their toilet on their own.

While selecting eligible households for providing incentive under the SBMG, the **following order of preference** shall be ensured:

A. BPL

B. APL

- (i) SC/ST
- (ii) Persons with disability (divyangjan friendly toilet to be ensured)
- (iii) Landless labourers with homestead
- (iv) Small farmers
- (v) Marginal farmers
- (vi) Women headed households

While ensuring the above order of preference, **priority may be accorded** to cover the households (against each category mentioned above) having:

- Old Age Pensioners / Widow Pensioners / Disability Pensioners (National Social Assistance Programme {NSAP} beneficiaries) / Transgenders
- Pregnant and lactating mothers covered by Maternal Health Programmes of Central and State Governments, including Janani Suraksha Yojana under National Rural Health Mission; and,
- Girl children covered by any scheme benefiting the girl child

The identification of such households should be initiated by the Gram Panchayat in Gram Sabha meeting and to be approved by Block and District levels authorities. The details of such new households shall thereafter be entered in SBMG IMIS of DDWS with Aadhaar Seeding as per the extant guidelines of the Government of India in this regard.

APL families not covered by the above incentives will be motivated and triggered to take up construction of the household latrine on their own.

All the BPL and APL families will be motivated to self-construct their toilets using trained masons so that safe technology as per standard design specifications can be ensured for sustainability.

During construction of household and community toilets, it should be ensured that there is no contamination of ground water and water sources. For this, standard design specifications such as pit depth etc. and safe distance from water sources should be adhered to.



5.2 Retrofitting of toilets

Retrofitting is an action or measure to address a technological gap/problem affecting a toilet's functionality and excreta management process including its sanitary status, e.g. incorrectly constructed pits, faulty pipes and chambers, absence of 'Y' junction, weak or damaged superstructures, pit cover and poor plinth foundation, inappropriate distance between pits, depth of pits, or wrongly built septic tanks. These technological problems can usually be addressed with a few low cost and easy solutions which are provided in the 5 days Resource Booklet for Sujal and Swachh Gaon² developed by DDWS. States and Districts shall undertake necessary IEC and IPC interventions to motivate households to retrofit their toilets, wherever needed.

5.3 Construction of Community Sanitary Complexes (CSCs)

ODF-plus villages must endeavour to have at least one CSC which may cater to the sanitation needs of floating population. The GP will decide upon a suitable location for construction of CSC that is easily accessible to all, having adequate water availability and where long-term O&M is ensured. For the construction of CSC, priority shall

be given to the locations with predominant SC / ST habitations, poorest of poor in the village and/or those visited by migrant labourers / floating population etc.

The CSCs shall have separate facilities for men and women, and shall consist of an appropriate number of toilet seats, bathing cubicles, washing platforms, wash basins, etc. The CSC should be accessible for Divyangjans.

Financial assistance for a CSC will be as per the funding norms given in the Programme Funding section. However, emphasis is to be given to PPP mode for setting up of such projects and self-revenue generation models for meeting the O&M costs of such complexes. O&M of such complexes will ultimately be the responsibility of the GPs. The GPs should also endeavour to operate and maintain the CSC through 'Pay and Use model', wherever possible.

Technological details for IHHL and CSC are given in Annexure – I. For construction of community toilet for the benefit of the people with diversion of forest land for non-forestry purposes under Forest (Conservation) Act, 1980, guidelines of Ministry of Environment, Forest and Climate Change dated 8th November 2016 are attached at Annexure – XIV.

²[https://swachhbharatmission.gov.in/sbmcms/writereaddata/Portal/Images/pdf/Sujal%20and%20Swachh%20Gaon%205-day%20Manual%20\(6%20Sept\).pdf](https://swachhbharatmission.gov.in/sbmcms/writereaddata/Portal/Images/pdf/Sujal%20and%20Swachh%20Gaon%205-day%20Manual%20(6%20Sept).pdf)

5.4 Works for solid waste management

Villages must be provided with an adequate number of individual and community compost pits for biodegradable waste including agricultural & cattle waste, and an adequate segregation and collection system for plastic waste. States will have the flexibility to adopt technologies as per their need and context.

Solid waste management activities can be implemented by the Gram Panchayat or by engaging an agency/group of individuals or as per protocol prepared by the State Government/District Administration. The number and location of such assets should be as approved by the Gram Sabha / Block / District Administration and as indicated in the Action Plans. Agencies for implementation of activities, especially at Block and District levels should be carefully selected based on their past work experience, technical capability and value for money

5.4.1 Bio-degradable waste management

Department of Drinking Water and Sanitation promotes composting as the preferred method to manage bio-degradable waste in the rural areas. However, States have the flexibility to choose the technology option best suited for local conditions. Technology and management options for the management of bio-degradable waste are given at Annexure – II.

5.4.1.1 Composting

Composting is a method of solid waste management whereby the organic component of the solid waste is biologically decomposed and stabilized under controlled conditions to a state where it can be handled, stored and/or applied to the land without adversely affecting the environment. The process allows the development of thermophilic temperatures and as a result of this biologically produced heat, the final product (compost) is stable, free of pathogens and plant seeds and can be beneficially applied to land.

A. Household level Compost pit

Household level compost pits are to be selected where space is available, away from drinking water source and where waterlogging never occurs, and the funding will be through convergence.

Specification and Size

- Pits of adequate size to bury the bio-degradable waste of 6 months in each pit.
- Pits of dimension: length 1m x width 60 cm x depth 1m for a family of 5 or 6 members.
- Bigger size pits for bigger families according to requirements.

B. Community level Compost pit

Community level compost pit of minimum size 3.6m x 1.5m x 0.9m (length x width x height) (4.86m³) can be constructed for a minimum of 100-150 households and pit size can vary based on the quantity of waste generated also. One unit of Compost pit for 100-150 households will consist of two pits of 4.86m³ capacity each. When one pit gets filled up in six months, the next pit can be used. By the time second pit fills up, the compost from first pit can be removed and utilised.

The following points should be kept in view for selecting the site for compost pits

- (1) The site for the pit should not be located in low-lying areas and areas prone to water stagnation or areas near water bodies.
- (2) The site should be easily accessible for transportation of waste and manure.
- (3) The site should not be selected where the water table is high and closer to the surface.
- (4) Site should be selected taking into consideration the wind flow direction, so that inhabited areas don't get any foul odour.
- (5) A bund around the periphery of the pit should be formed to prevent draining of water into the pit.
- (6) The sides of the pit shall be vertical or sloped as per the soil conditions.
- (7) The number and size of the pits are permitted to be altered as per site requirements and land availability and quantity of biodegradable waste generated.
- (8) If there are industrial/ commercial/ market centres, the volume of the garbage generated shall also be calculated and additional number of pits shall be provided.
- (9) It is advisable that suitable modification of clusters should be done as per the requirements depending upon the quantum of waste generated, number of habitations and number of households and space availability for digging up the compost pits. The distance between the pits should be at least 1.5m.
- (10) Wherever possible, the pits should be dug up considering one habitation as the unit. Pits should be dug up for a cluster of two or more habitations only if the population of the habitations is very low.



5.4.1.2 GOBAR-dhan (Galvanizing Organic Bio- Agro Resources–dhan)

GOBAR-dhan is an integral component of SWM for ensuring cleanliness in villages by converting bio-waste including animal waste, kitchen leftovers, crop residue and market waste into biogas and bio slurry to improve the lives of villagers. This is also useful in providing economic and resource benefits to farmers and households.

GOBAR-dhan projects support biodegradable waste recovery by incentivizing Gram Panchayats to convert cattle dung and solid agricultural waste into biogas and bio-slurry. Gram Panchayats may implement this scheme for maximum bio-waste recovery alongside other initiatives like composting and vermi-composting.

Under SBMG, financial assistance (as prescribed under the programme funding section) will be provided for model GOBAR-dhan projects at the district level to encourage further scaling up of GOBAR-dhan projects at lower levels (minimum 10 projects per Block to be taken up). For model GOBAR-dhan projects, the districts should preferably take up community-level projects near Gaushalas for uninterrupted supply of organic wastes to make the projects sustainable in the long run as well as to promote business models. However, the district will have the flexibility to take up household level projects wherever

feasible. Guidelines for setting up GOBAR-dhan projects is given at Annexure –III.

The biodegradable waste generated in peri-urban villages and other villages, near to CBG (Compressed Biogas) plants set up under SATAT Scheme of Ministry of Petroleum & Natural Gas, can be utilized in such CBG plants.

5.4.2 Plastic waste management

Plastic waste management refers to the collection, storage, transportation, and disposal of plastic waste in an environmentally safe manner. For plastic waste management in rural areas, the following functions need to be carried out:

- a) Segregation, collection, storage, transportation of plastic waste and channelization of recyclable plastic waste fraction to recyclers having valid registration; ensuring that no damage is caused to the environment in the process
- b) Awareness generation among all stakeholders about their responsibilities
- c) Prevention of open burning of plastic waste

Implementation of Plastic Waste Management would involve the following

- Storage Facility at Village level

- o Material Recovery Facility/ Plastic Waste Management Unit at District / Block level

Preparation of Action Plan at Village level – guidance note

Within the overall action plan of a village, following needs to be noted for solid waste at GP level:

- a) Assessment of waste (type and quantity) generated at various levels viz. household level, institutions, health care centres, commercial areas and market areas.
 - b) Segregation of waste in every household, commercial centres, institutions and handing over to the collection facility at the GP.
 - c) Establishment of collection and aggregation centres (sheds at village level): Linkages may be established with existing and upcoming aggregation centres to systematically reduce transport costs. This will make collection viable for local entrepreneurs / GP / SHGs.
 - d) All forward linkages to be established and mentioned clearly in the plan document.
 - e) Transportation of plastic waste from these collection and aggregation centres (sheds at village level) to Block or district level, where Plastic Waste Management Centres (PWMC) will be set up. Such a centre will have one shredding and bailing machine to reduce the volume of the plastic waste collected.
- f) For collection and transportation of plastic waste, the same vehicles with partition of bio-degradable and non-bio-degradable waste may be used.
 - g) List of scrap dealers in the district to be prepared and included in the plan. If possible, the name and details of cement industries in vicinity or within 150-200 KM to be enlisted.
 - h) The shredded and bailed plastic waste can be used for road construction (*ref. using plastic in construction of roads in the Indian Roads Congress code SP 98-2013*) or for co-processing in cement industries.
 - i) Formalize collection through entrepreneurs in rural areas. States must encourage individual or SHG oriented last-mile entrepreneurs for plastic waste collection and provide them with formal contracts at the village or GP level as well as connecting them to plastics aggregation points.

Details for setting up village level and Block level plastic waste segregation and collection systems, as well as management options for plastic waste management are given at Annexure – IV.

5.5 Works for liquid waste management

Villages must be provided with individual / community soak pits for greywater generated from kitchen use and bathing, and storm water. Provision may also be made for appropriate treatment systems for any black water from the overflow of septic tanks, as may be the need. States will have the flexibility to adopt technologies as per their need and context.

5.5.1 Greywater Management

Greywater management interventions will be undertaken in consonance with the implementation of Jal Jeevan Mission in villages as envisaged in the Village Action Plan for JJM. The amount of greywater, flow of greywater, discharge arrangements etc. shall be taken into consideration while designing greywater management interventions.

Greywater management activities will be undertaken as under:

- **Villages with less than 5000 population** should plan for *community level soak pits* based on the terrain, groundwater level and density of population. However, depending on the ground level situation, States will have the flexibility to take up a conveyance system like underground / small bore sewers / closed drainages and activities suggested for larger villages like WSP / DEWATS / constructed wetlands and other treatment systems with additional funds support from the 15th Finance Commission and

convergence from other State funds.

- **Villages with more than 5000 population** should plan for a conveyance system like underground / small bore sewers / closed drainages and treatment systems like WSP / DEWATS / constructed wetlands and other treatment systems based on terrain, groundwater level and climatic conditions.

Bigger villages (with population above 5000) should be given priority for taking up Greywater management. Further, while selecting the villages for Greywater management, convergent approach with JJM should be adopted for identifying the villages where piped water supply has been provided/planned under JJM.

Drainage channels (drainage of greywater from household up to the disposal or management) have to be provided by the GPs with their 15th Finance Commission grants and / or through convergence with MGNREGS or other schemes of State or Central Governments. The drains must direct greywater to one of the above structures, and not drain it into a river, pond, natural water body or piece of land.

Department of Drinking Water and Sanitation promotes soak pits as the preferred method to manage greywater in the rural areas. However, States have the flexibility to choose the technology option best suited for local conditions. Technology and management options for the management of greywater are given at Annexure – V.

5.6 Faecal Sludge Management

Faecal Sludge Management shall be taken up for those households where retrofitting is not possible.

Faecal Sludge Management involves judicious selection of one of the three interventions: trenching, co-treatment or an FSM Plant. For peri-urban or densely populated villages in which many households may have septic tanks, co-treatment options with existing Sewage Treatment Plant (STP) facilities of nearby urban or rural areas should be employed wherever possible.

Faecal Sludge Management Systems (FSMS) An FSMS may be considered if co-treatment is not possible due to long-distance travel of vehicles containing faecal sludge. The FSMS may be taken up for a single large

village or a cluster of villages / GP through any one of the following interventions.

- a) **Deep row entrenchment (Trenches)** This option may be adopted for a cluster of villages where less quantity of faecal sludge is collected. This technology is not appropriate for villages close to water bodies (rivers, lakes and coastal areas) and also where the groundwater level is high.
- b) **Faecal Sludge Treatment Plant – Unplanted / Planted drying bed** This may be adopted for a cluster of villages with a significant generation of faecal sludge.

The above categorization is only indicative and further details at Annexure - VI.

FSM Implementation Approach Matrix

Type of Containment	Context or Issue	Remedy	Alternative option
Twin pit system	Leaks in the Y-junction	Retrofit	Co-composting or solar drying with long storage is recommended for material recovered from pit emptying
	Less than 1m between pits	Retrofit	
	Rim of pits are allowing rainwater to enter pit	Retrofit	
	In high water table area or too close to groundwater source	Upgrade to in-situ treatment	Implement FSM
Single pit	All single pits will be considered for upgradation; those in high water table areas or too close to groundwater sources will be given high priority	Upgrade to in-situ treatment	Implement FSM
Septic tank	Applicable for census towns or peri-urban areas	De-sludge every 3-5 years (as required)	Implement FSM

A **District FSM Plan** should be developed by the DWSM/DWSC using the following guidance note:

- An assessment of the number, capacity and location of existing Sewage Treatment Plants (STPs) and Faecal Sludge Management Plants (FSMPs) available in the District, established under various schemes of State and Central Governments or by a private entity. Basic proximity analysis of all STPs/FSMPs at the district level will reveal the number of villages that can be covered with a co-treatment option. This may be given the highest priority as it reduces the need for constructing a new Faecal Sludge Management Plant.
- An assessment of the number of households with single pit / septic tank toilets.
- Need for desludging of septic tanks and pit latrines at regular intervals.
- Mechanised cleaning / emptying of pits and transportation of faecal matter to treatment point is to be ensured through business model or convergence with other schemes of Central or State Governments.
- Selection of technology that is best suited to the local context.
- Operation and maintenance requirements and costs.

Identification of site for location for FSM The DWSM/DWSC shall ensure the following while identifying the location/site for FSM. The location:

- is easy to approach, has sufficient space for sheds, rooms and

parking of vehicles containing sludge and others

- is not near a water body which could get contaminated
- is not litigated and has clear tenancy established
- will not pose any challenge to the aesthetics and environment of the area

Identification of the agency for construction and management

The DWSM/DWSC should advertise seeking expression of interest from agencies to construct, own, operate and manage the FSM unit. Only such an agency should be selected which:

- has some prior experience or demonstrated technical ability to manage an FSMS
- possess the business acumen to run the unit with a revenue-based model
- is the most efficient

Operation and Maintenance

Districts should standardize *desludging fee* based upon certain criteria like APL/ BPL families, the type of infrastructure, i.e. specific rates for pits, septic tanks and also distance to management sites. Districts are responsible for operation and maintenance of faecal sludge management systems. SHGs, entrepreneurs and voluntary organizations will be encouraged to participate and take up treatment and commercial sale of end products. It is hoped that the above will make O&M sustainable through revenue generation model(s) as well as funding support through interest subvention, as per the applicable provisions.

6

INFORMATION, EDUCATION AND COMMUNICATION (IEC)

SBMG Phase II is not just about constructing infrastructure for ODF Plus villages but aims at behaviour change of the masses to adopt better sanitation and hygiene practices. Therefore, information, education and communication (IEC) strategies, planning and their effective implementation is the key to the success of the Mission. In view of this, IEC activities are not to be treated as 'stand-alone' activities or a 'component' of the Mission, but the Mission itself is largely about effective IEC to nudge communities into adopting safe and sustainable sanitation practices. An important feature of the IEC in SBM Phase II would be



hygiene promotion through core SBM Phase II activities as listed above.

Provision for IEC and Capacity Building for SBMG Phase II will be up to 5% of the total project expenditure with up to 2% to be utilized at the Central level and up to 3% at the State/district levels.

The 3% at State level shall be used on IEC/BCC/IPC and all related communication activities, and capacity building. The State must put in its share of funds for IEC in the Centre to State ratio of 60:40 for all States except for NER/special category States where the sharing ratio is 90:10.

6.1 Role of States for IEC

States/UTs shall lead IEC/BCC activities and be responsible for the percolation of BCC interventions across the State.

- **Fund allocation** The State level implementing agency may decide the proportion of funds to be spent by the State and districts, out of the 3% funds earmarked for IEC and capacity building activities.
- **BCC/IEC Strategy Planning** States are to ensure that Planning and Budgeting exercise for IEC/BCC activities is done for all districts as part of their District Swachhata Plans. State-level Plan for IEC shall be approved by the State Level Scheme Sanctioning Committee.
- **Operationalise State Level Activities** States are to develop their own IEC campaigns, scale-up IEC campaigns of the Centre, and monitor the implementation of local IEC campaigns run by districts.
- **Other roles of the States**
 - Ensuring all IEC positions at the State and district

level HR structure are filled appropriately

- Engaging relevant agencies, liaison with Development Partners and forming partnerships to implement the IEC/BCC Plans in the State including hygiene promotion
- Regular monitoring of progress and timely reporting on the IMIS
- Contributing to 'Swachh Sangraha' - Knowledge Management Portal of SBMG
- Facilitating workshops, conferences, and consultations from time to time for advocacy, capacity building and knowledge sharing among officials at grassroots, media, sector experts, sanitation policy researchers, etc.



6.2 Role of Districts for IEC

- **Planning** Districts shall prepare a detailed IEC plan as the first part of their Annual Implementation Plans as per their overall strategy to reach all sections of the community. This is to be done with the resource of IEC consultants at the district level and the State level. Support of local NGOs may be taken for interpersonal communication, selecting motivators, triggering activities etc. Assistance of other agencies with expertise in preparing and implementing IEC, BCC plans can be taken. The Annual IEC Action Plan should be approved by the DWSC/DWSM. IEC Plans for the district should also be

outlined in the relevant sections of the District Swachhata Plan. Based on this plan, districts are to develop an annual calendar of IEC activities and share it with the State Mission.

- **Funding** Funds required for implementing the IEC plan may be provided to Blocks, Gram Panchayats and/or agencies involved in its implementation, under the IEC component.
- **Staffing** Ensure enrollment of one or more IEC Consultants at the district level
- **Use of social media** Maintain active Facebook and Twitter pages to showcase work being done by the district under SBMG including hygiene promotion.
- Monitor IEC implementation in all GPs



6.3 IEC channels available for use by States, Districts and GPs

○ **Interpersonal**

Communication The most part of the State's IEC mandate is the use of interpersonal communication at local level to strengthen behaviour change for improved sanitation and hygiene. States are to use Swachhagrahis at the village level to change behaviours at individual, household and community levels. They may do so using a range of other interpersonal communication including wall paintings, door to door campaigns, village meetings, nukkad nataks, Community Radio, Swachhata Raths, for connecting directly with local communities. DDWS will also develop IPC material from time to time which are to be disseminated by the State to all villages through the districts and GPs. These will be geotagged and tracked through the IMIS.

- **Mass Media** Amplification of National IEC advertisements on TV/Radio/Community Radio, and/or creative design of State-specific creative material for mass media dissemination.
- **Development of new Creative Material** The development of all material/templates may be standardized by the district or the State Mission, if required, in consultation with expert agencies.
- **Use of social media** Maintain active Facebook and Twitter pages around Swachh Bharat Mission at State/district level.
- **Regular felicitation of local champions and leveraging local celebrities**
- **Collaboration with other agencies** Other institutions like schools, Anganwadis, local groups, faith-based leaders and natural leaders, may be collaborated with to enhance the outreach of sanitation messages at all levels.

6.4 Key IEC Messages for ODF Plus

For bringing behaviour change, following key issues can be focused. The IEC efforts at all levels must be geared to deliver these messages in an impactful way through the use of culturally sensitive and gender-sensitive humour, case studies, success stories, and celebrity-based messaging, among others:

- 1. Waste Segregation at Source**

The first and foremost step in solid and liquid waste management is waste segregation at source. Households are to be encouraged to maintain separate bins for wet and dry waste so that the two may be collected separately and taken up for appropriate management through biogas plants or composting for wet waste and plastic waste treatment for dry waste.
- 2. Plastic Waste Management**

Campaigns must be run to generate awareness about the 4R's - Reduce, Reuse, Refuse, Recycle - to make people aware of the ways to minimize the plastic waste generated at their homes and villages. States and districts may set an example by popularizing Green Events at all levels in the Government that are organized as Zero Plastic Events.
- 3. Greywater Management**

Households must be made aware of the importance of and various technological options available for managing waste water coming from their kitchen, bathroom and storm water. This includes soak pits, leach pits, waste stabilization ponds, etc. at household or community level.
- 4. Bio-degradable Waste Management**

Households must be encouraged to manage their wet waste either through a compost pit or a biogas plant, or any other suitable organic waste management technology at the household or community level.
- 5. Faecal Sludge Management**

Households must be educated of the toilet technology that their household toilet is designed with, and how their toilet waste is to be managed, depending on this technology. This includes emptying toilet pit of a twin pit toilet, and other faecal sludge treatments systems for toilets with single pits and septic tanks.
- 6. Retrofitting**

Households should be educated if their toilet needs retrofitting and know the options and recourses they can adopt.
- 7. Menstrual Waste Management**

The State, district and GP to spread awareness about menstrual health management among young girls and women under various programmes of the Health and WCD departments. To support this, IEC funds for SBM Phase-II may also be used

to generate awareness about Menstrual Waste Management. Campaigns are to be conducted to make adolescent girls and women aware of ways to reduce menstrual waste, through use of products like menstrual cups, reusable sanitary pads, etc.

8. Hygiene Promotion Key hygienic practices must be promoted under the IEC component of SBMG Phase II. This includes behaviours like drinking water handling and storage practices, handwashing with soap after using the toilet and before eating food, cleaning and maintenance of sanitation facilities (including individual toilets as well as CSCs), no

littering in public places, no spitting in public places and other hygienic behaviours like covering mouth while sneezing, coughing, maintaining social distancing during communicable disease outbreaks etc.

Similar campaigns may also be run with sanitation workers at all levels, especially around safe handling of hazardous waste. The message that use of safety equipment is mandatory for sanitation workers should be delivered and repeatedly reinforced to sanitation agencies and contractors, and strict action be taken against the agencies that violate safety norms.



7

CAPACITY BUILDING



Following the achievement of ODF status in rural communities, the capacity of key stakeholders at the State, district and Block levels will need to be built to plan, implement and monitor ODF Plus activities. Stakeholders include VWSCs, functionaries of BWSC, DWSM, ASHA, Anganwadi workers, SHG members, masons, CSOs / NGOs, etc. The training may be on various aspects of ODF Plus, including promoting behavioural change through IPC, door to door visits, masonry work, plumbing, skills for maintenance of toilets, and other SLWM activities.

7.1 Training and orientation of all stakeholders

The District Swachhata Plan of each district will have details of the annual capacity building action plan covering every GP in the district, with identification of the training institute / agency, training components and the intended trainees, with definite timelines. This exercise may be monitored by district authorities, and the State SBMG Directorate.

Training workshops / refresher trainings for sensitization, awareness generation and technical know-how will be conducted to build the capacity of human resources to lead and sustain ODF Plus initiatives. In addition to rigorous technical training, orientation workshops may also be conducted at the State, district and GP levels as follows:

State level

1. States will constitute State Training Management Units (STMU) and ensure that a training plan is made for Training of Trainers (DTMU members) and field trainings (PRI and field functionaries viz. Swachhagrahis and other Swachhata champions ASHA, ANM, teachers etc.).
2. State and district IEC and / or capacity building plans will be prepared (on additional themes of ODF Plus, as required) on a quarterly basis to help mission staff work towards achievement of programme goals.
3. States will supervise and monitor implementation of above plans at State and District levels.

District level

1. Districts will constitute District Training Management Units (DTMU) and ensure that members complete ToTs to help them conduct capacity strengthening programmes for PRI members and field functionaries.
 2. DTMU will prepare calendar of event for the above trainings and also ensure that the trainings are completed as per schedule.
 3. Additional training will be provided to district level functionaries in implementing IEC and / or CB plans for ODF Plus, including its monitoring and evaluation.
 4. Training calendar (planning) will be prepared to provide extensive training to service providers, as necessary, in the construction (or retrofitting), repair and maintenance of assets for ODF Plus e.g. soak pits, compost pits, greywater management assets, FSM units or any additional skill, as necessary.
2. As per the plan / training calendar developed at State / district level, training will be provided to service providers in the construction (or retrofitting), repair and maintenance of assets for ODF Plus e.g. soak pits, compost pits, greywater management assets, FSM units or any other skills, as necessary.
 3. Training will be provided to Swachhagrahis, masons, VWSC members and nigrani samitis in the repair and maintenance of toilet hardware and technology upgradation (as applicable for their respective roles).
 4. Refresher/training will be provided to teachers to advocate on the importance of sustaining sanitation behaviours post the village achieving ODF status.

Gram Panchayat / Village level

1. Conducting sessions for capacity strengthening of PRI members and field functionaries (e.g. Swachhagrahis, other Swachhata champions viz. ASHA, ANM, teachers etc.) on elements of ODF Plus. This will



7.2 Swachhagrahis

The massive success of Phase I of the SBMG may be attributed to the large army of Swachhagrahis who mobilized and empowered communities to achieve ODF status in their villages. The Swachhagrahis will continue to be the frontline human resource for taking forward the ODF Plus initiatives.

Swachhagrahis are the foot soldiers of the Swachh Bharat Mission (Grameen) and the motivators for bringing about behavior change with respect to key sanitation practices in rural India. Every village should ideally have at least one Swachhagrahi, with preference given to women candidates. A Swachhagrahi is a volunteer who can come from any background, including a local ASHA worker, ANM, Anganwadi worker, and staff, water line man, pump operator, member of NCO/CSOs, youth organisations or from the general public living in villages.

The role of Swachhagrahis remain critical even in the ODF Plus phase of the programme, as they play a crucial role in sustaining the ODF status of their villages and supporting the mission in rollout of SLWM initiatives.

In this, the following will be critical:

- Sustained engagement with the Swachhagrahis
- Systems for continued capacity building and motivation of Swachhagrahis

- Appropriate incentives for this sustained engagement

7.2.1 Role of Swachhagrahis

The role and responsibilities of Swachhagrahis can be grouped as given below during the implementation phase.

1. Facilitating Toilet Construction
2. Retrofitting and improvisation of assets
3. Facilitating sustained behavior change
4. Promoting Public health and hygiene
5. Supporting rollout of SLWM activities

Swachhagrahis shall undertake the 5-day Swachh and Sujal Gaon training to begin with and shall also undertake other training/ orientation/ skill building courses recommended by the department from time to time.

7.2.2 Incentives for Swachhagrahis

For supporting the rollout of initiatives in the Phase-II of the programme, Swachhagrahis will undertake the above activities and receive payment of incentives from IEC & Capacity Building budget subject to confirmation on achievement of the same and as per the incentive structure advised by GoI (Annexure - VII).

8

INSTITUTIONAL ARRANGEMENTS



8.1 National Scheme Sanctioning Committee

The National Scheme Sanctioning Committee (NSSC) will be constituted for specific periods to approve or revise the Perspective Plan called the Project Implementation Plan (PIP) for the States/UTs, and the Annual Implementation Plan (AIP) as and when received from the State / UT Governments duly approved by the State Level Scheme Sanctioning Committee (SLSCC) and finalized by the Appraisal Committee.

The constitution of the NSSC shall be as follows:

1. Chairperson: Secretary, Department of Drinking Water and Sanitation
2. Special / Additional / Joint Secretary and Financial Advisor, Department of Drinking Water and Sanitation
3. Joint Secretary, Ministry of Panchayat Raj, GoI
4. Joint Secretary, MNREGS, Ministry of Rural Development, GoI
5. Secretary in-charge of rural sanitation of the State whose proposal is to be considered
6. Additional Secretary / Joint Secretary in-charge of Sanitation, Department of Drinking Water and Sanitation - Member Secretary
7. Two experts on rural sanitation as nominated by the Chairperson

8.2 State Water and Sanitation Mission

Each State has a State Water and Sanitation Mission (SWSM) whose composition should be reviewed to ensure that it has representation of State Departments dealing with Rural Sanitation, Rural Drinking Water, School Education, Health, Women and Child Development, Panchayati Raj, Water Resources, Agriculture, Publicity, etc. as a step towards achieving coordination and convergence among line departments in the State for implementation of SBMG. It shall be a registered society under the aegis of the Department / Board / Corporation / Authority / Agency implementing rural drinking water and sanitation programmes in the State.

8.3 Apex Committee

While States shall decide on an appropriate structure, there should be an Apex Committee at the State level to aid and advise the State SBMG Mission (SSBMG). The Committee should be headed by the Chief Secretary with Secretaries in-charge of PHED, Rural Development (RD), Panchayati Raj (PR), Finance, Health, Information and Public Relations (I&PR) as members. Principal Secretary / Secretary of the Department in-charge of rural sanitation in the State shall be the nodal Secretary responsible for all the SBMG Phase II activities and for convening the meetings of the Mission. Experts in the field of sanitation, hydrology, IEC, HRD, MIS, media, NGOs etc. may be co-opted as members.

8.4 State Mission or SSBMG

Located within the implementing department of the State Government

Chairperson of the Governing Body

Minister-in-Charge of the Department

Vice Chairperson Principal Secretary / Secretary in charge of the implementing Department

Member Secretary Mission Director

Role The SSBMG headed by a senior State level official shall supervise implementation of SBMG Phase II in the project districts of the State, facilitate convergence mechanism between line departments, ensure preparation of the Annual Implementation Plan (AIP) / Project Implementation Plan (PIP) for each district as per requirement, consolidate the same into the Annual

Implementation Plan / Project Implementation Plan of the State, share and discuss the same with the DDWS, receive Grant-in-aid from Centre and disburse to the DWSSMs / Zila Parishad / DRDA / Block / GP as per requirement.

Staffing States shall provide adequate administrative, technical and support staff for the State Mission. Remuneration of all Government employees in the Mission will be borne by the State. The State can engage technical experts as Consultants under the programme.

Accounting arrangements for the SBMG As existed for the SWSM, and as amended by the DDWS and State Government from time to time.

The administrative support component of the SBMG should ideally consist of the following human resources, additional numbers, specialists may be hired as necessary. States will have the flexibility to decide on the mode of engagement (hiring or deputation or co-opting), number of positions, experience and skillsets etc. as per their need and State context. Following is an indicative structure that may be used:

Director	1
State Coordinator	1
Consultants	
HRD / Capacity Building Specialist	1
IEC Specialist	1
M & E Specialist	1
SWM Specialist	1
LWM Specialist	1
MIS Specialist	1
Accountant	1
Data Entry Operator	2

The remuneration of these positions should be in parity with the emolument

structure of other programs (like NRLM, MGNREGS etc.).

8.5 District Swachh Bharat Mission

The District Swachh Bharat Mission Grameen [DSBMG] is to be retained at the district level with suitable changes in the existing District Water and Sanitation Mission / Committee (DWSM/DWSC). As the line departments will play a catalytic role in the implementation of the programme, the role of the District Collector / District Magistrate / CEO Zila Panchayat shall be pivotal.

While States shall decide on an appropriate mechanism, the suggested composition of DSBMG is as follows:

- DSBMG shall be headed by Chairman of the Zila Parishad.
- Executive Vice Chairperson: District Collector / Deputy Commissioner / District Magistrate / CEO Zila Panchayat
- Members: All MPs / MLAs and MLCs of the district and Chairperson of the concerned Standing Committees of the Zila Parishad or their representatives; CEO / AEO of the Zila Parishad; District Officers of Education, Health, Panchayati Raj, Social Welfare, ICDS, PHED, Water Resources, Agriculture, Information and Public Relation;
- Block Presidents (Block Pramukh) may also be nominated by ZP President on rotational basis.
- NGOs can be identified by the DSBMG and co-opted into the Mission as members.

- CEO of the District Panchayat / Parishad; the Executive Engineer of PHED / District Engineer of the ZP / any other officer approved by SSBMG shall be the Member Secretary.
- The Mission shall meet at least once a quarter.
- DSBMG should plan and advise on implementation of the SBMG in the district with appropriate IEC strategies and convergence mechanisms with all line departments.

The Mission/Committee will carry out regular Block and GP level reviews. The District Collector / Deputy Commissioner / District Magistrate / CEO Zila Panchayat shall be the nodal officer responsible for the implementation of the Mission. Remuneration of all Government employees in the Mission will be borne by the State. The DSBMG can engage technical experts as Consultants under the programme.

Accounting arrangements for the DSBMG shall be as existing for the DWSM, and / or as amended by the DDWS and State Government from time to time.

At the implementation level of the district, the administrative support component of DSBMG should ideally consist of the following human resources, additional numbers, specialists may be hired as necessary. Districts will have the flexibility to decide on the mode of engagement (hiring or deputation or co-opting), number of positions, experience and skill sets etc. as per their need and the District's context.

District Coordinator i / c of SBMG	1
Assistant Coordinator (Tech.)	1

Consultants

IEC Specialist	1
HRD and Capacity Building	1
M & E cum MIS	1
SWM	1
LWM	1
Accountant	1
Data Entry Operator	2

a track record of good performance may be retained and additional appointments made, as necessary. The remuneration of these positions should be in parity with the emolument structure of other programs (like NRLM, MGNREGS etc.)

States may decide on the specializations, experience and skill sets of all consultant (Specialist) positions. All existing Consultants with

Note *The District should retain the ODFS Cell created and re-designate /redeploy them for the implementation of SBMG Phase II.*



8.6 Block Water and Sanitation Committee

The role of Block in the implementation of ODF plus shall be significantly strengthened to provide guidance, support and monitor implementation of ODF plus in GPs. Ideally, the State may set up a Block Water and Sanitation Committee (BWSC) for each of the Development Blocks. The BWSC should be set up under the leadership of Block Development Officer. The BWSC shall have, at minimum:

Block Coordinator	1
SLWM Coordinator	1
Data Entry Operator	1

The above may be engaged on contract and shall be provided emoluments as decided by the States. The BWSC shall work as a bridge between the district and the GPs, and provide continuous support in terms of awareness generation, motivation, mobilization,

training and handholding of village communities, and GPs. This Block level arrangement shall be tasked with hand holding, supervising and monitoring of the programme and the quality of assets being constructed and their usage and maintenance in every GP. The BWSC could serve as an extended delivery arm of the District Mission in terms of software support and act as a link between [DSBMG] and the GPs / village communities. It is recommended that all IMIS related data entry may be undertaken at the Block level and may only be brought to the district level for approvals and monitoring, as may be necessary.

Capacity building and generating awareness including triggering demand among the community on various aspects of ODF plus will be taken up by BWSCs through the designated CSO / Swachhagrahis etc. It will also help the GPs in sustaining ODF status, and management of solid and liquid waste.



8.7 Gram Panchayat / Village Water and Sanitation Committee

The Gram Panchayats have a central role to play in SBMG Phase II. They shall lead the planning and implementation of all software and hardware components of the Phase II programme. The GPs will lead the planning process for all activities to be constructed at village level under the Swachh Bharat Mission Phase II and lead the implementation through community mobilization for triggering demand, hygiene promotion, IEC and capacity building and construction and maintenance of toilets and SLWM assets. Gram Panchayats shall have the delegated authority to hire experienced and reputed NGOs / institutions for assisting in carrying out inter-personal communication and training, construction and management of Community Sanitary Complexes



and Solid and Liquid Waste Management infrastructure.

A **Village Water and Sanitation Committee (VWSC)** may be constituted as a sub-committee of GP, for providing support in terms of motivation, preparation of Village Action plan, mobilization, implementation and supervision of the programme. The membership of a VWSC may have representation from each Ward of the GP and 6 more members. Women should form at least 50% of the members. There should be representation from SCs and STs and poorer sections of the society in proportion to their population in the GP. This committee should function as a Standing Committee on Water and Sanitation of the GP and should be an integral part of the Village Panchayat. The composition and functions of the VWSC can be determined by the State Government. “Sarpanch / Pradhan” of the GP should be the Chairperson of each VWSC.



9

ROLE OF PANCHAYATI RAJ INSTITUTIONS



As per the Constitution 73rd Amendment Act, 1992, Sanitation is included in the 11th Schedule. Accordingly, GPs have a pivotal role in the implementation of SBMG. The programme will be implemented by the PRIs at the cutting edge. PRIs will play a very important role, especially now that the 15th Finance Commission has provided earmarked funding for sanitation activities.

9.1 Planning

Each Gram Panchayat shall develop a Village Swachhata Plan for each financial year involving people from all villages, especially women and marginalized people and ensure that a credible plan is developed to sustain the ODF status and improve solid and liquid waste management in the villages. The GP shall feed the plan as per GPDP planning principles in the designated Plan Software, as well as into the SBMG

IMIS. The Gram Panchayat through its officials and staff, viz. Panchayat Secretary and Panchayat DEO, will ensure that any change in plan is immediately reflected in both softwares. All physical and financial progress shall also be immediately updated in both the designated softwares.

9.2 Fund Flow

GPs shall also be the recipient of funds, subject to conformity with State arrangements, and shall also contribute from their own resources for the financing of community toilets, and solid and liquid waste management infrastructure. The GP shall also ensure the correct site selection for building community toilets in all villages, and to especially ensure that areas of the GP with larger populations of weaker sections of society including SC / ST population may receive priority in this regard. The list of

activities that need to be funded by Gram Panchayats using the 15th Finance Commission and MNREGS funds are placed as Annexure – VIII. Gram Panchayats shall ensure that all tied funds for sanitation are invested and utilized as prescribed in the guidelines issued jointly by Department of Drinking Water and Sanitation and Ministry of Panchayati Raj. All institutions and committees working within the GP framework have to prioritize sanitation within their programmes.

9.3 Coordination

Districts shall provide support to GPs for engagement with businesses, corporates, social organizations, and institutions like banks and insurance companies for

the creation of assets and O&M. The GPs shall act as the custodian of the assets such as the Community Sanitary Complexes, environmental sanitation infrastructure, drainage etc., constructed under SBMG.

9.4 Monitoring

Both Block level and district level PRIs shall regularly monitor the implementation of the programme. GPs shall also play a role in the monitoring of the SBMG programme. The GP will organise and assist in organizing Social Audits of the programme. Social Audit meeting will be held in each GP once in six months. The DSBMG and the BWSC shall be responsible to ensure that this schedule is adhered to.



10

ROLE OF COMMUNITY BASED ORGANISATIONS / NON-GOVERNMENTAL ORGANISATIONS / SELF HELP GROUPS / SUPPORT ORGANISATIONS



CBOs / NGOs / SHGs / other organisations can play a catalytic role in the implementation of SBMG Phase II. Such organisations can provide the outreach and ground-level connect which can be tapped in the programme to achieve positive results. They can be actively involved in the IEC activities including in triggering leading to demand generation, in capacity building, assistance in construction and ensuring sustained use of sanitation facilities, and hygiene promotion.

10.1 Rural Sanitary Marts

Rural Sanitary Marts could become an important source for strengthening supply chain for materials required to build individual household latrines, community, school and Anganwadi toilets and supporting implementation of SLWM arrangements. CBOs / NGOs / SHGs / other organisations may be engaged effectively in ensuring quality bulk supply of hardware for toilets, CSCs and SLWM interventions. RSMs can also enter into agreements with Blocks / Districts for operation and maintenance of CSCs and SLWM assets created in villages.

11

MARKET LINKED SLWM INTERVENTIONS



SBMG Phase II will focus on scalable and commercially viable solutions to make the sanitation economy attractive to private businesses. Treatment of faecal sludge, wastewater, biodegradable waste and plastic waste and their commercial sale could turn sanitation and waste management into profitable business. States through Districts / Blocks may provide technical training at village levels to the local youth for their employment benefit. Potential exists for the private sector to engage in providing services and undertake demand generation activities. In addition, this will result in revenue generation opportunities for community organizations viz. SHGs / VOs / CLFs and contribute to the growth of the local economy.

The programme will strive to generate revenue through SLWM activities. These will provide for efficient and decentralized O&M of services, help recover costs over a period, and support operation, thereby ensuring sustainable services.

The customary benefits of private sector engagement in sanitation include expertise in service delivery, transfer of technology and innovations as well as long term sustainability of service provision. The avenues of engagement for engaging private sector in rural sanitation could be:

- (1) **Infrastructure creation**
Providing technical assistance in developing innovative and low-cost models of latrine and SLWM infrastructure
- (2) **Operation and Maintenance**
Developing and disseminating sustainable business models for O&M of community and household level sanitation infrastructure
- (3) **Creation of market linkages**
Raising demand for sanitation value chain products by providing market linkages and financing options to local businesses

The above interventions would attract SHGs, entrepreneurs and voluntary

organizations and promote revenue generation models for collection of waste, treatment and commercial sale of end products.

To develop sustainable sanitation and waste management business models in India, it is important for local entrepreneurs with the know-how of waste management to pair up with governing bodies like, GPs, Block Development Offices and Zila Parishads and create a formal relationship.

State and Districts will work with businesses / SHGs for waste processing and the by-products would be marketed for revenue generation and sustainability. State Governments may facilitate sale and purchase of products.

Plastic Waste Management Unit at Block level also has potential to generate revenue. Suitable technological options may be explored for treatment of Plastic waste. Block level officers may establish linkages with registered local recyclers / aggregators to collect the dry waste from plastic waste management units periodically. The periodicity of waste can be decided based on plastic waste being generated. District / Block officials would facilitate the buy-back arrangements with road contractors for utilizing plastics in ongoing road construction projects in their district.

DWSM/DWSC may also tie-up with cement companies present near their district for utilizing plastic in cement kilns.

Management of liquid waste and greywater also has huge market potential. SBMG Phase II would support the creation of Waste Stabilization Ponds in large villages for greywater management. GPs may lease out these waste stabilization ponds in a GP to entrepreneurs interested in pisciculture, fox nut farming, duckweed farming, water chestnut farming, etc. Annual rates for these ponds would be decided by GPs and allocated to interested individuals / organizations / entrepreneurs / SHGs / companies based on a competitive tender. GP could also sell treated wastewater to farmers for agricultural purposes.

FSM operations provide business opportunities for service providers and also for FSMP operators. Private organizations/ truck owners can involve in mechanized collection and transportation of faecal sludge. FSMPs / FSTPs could be operated profitably through selling the by-products like compost, biogas and treated water which may be used for agricultural purposes. MoU may be signed with ULBs for treating the faecal matter in co-treatment with STP/FSMP located in Blocks/districts.

12

CORPORATE SOCIAL RESPONSIBILITY



Corporate houses should be encouraged to participate in the SBMG Phase II, as an essential part of the Corporate Social Responsibility (CSR). There is realisation that a healthy workforce can contribute towards better services for their output. Getting popularity for marketing of their products and services or mere status also attract corporate houses towards taking up social causes and increasing interaction with people. Thus, SBMG can serve as a platform for the corporate houses to help address their CSR.

The DDWS has issued the Corporate Collaboration Framework³ which suggests how corporates can associate with the SBMG. The Corporate / PSUs may take up the issues of sanitation through IEC, capacity strengthening or through direct targeted

interventions at all levels in collaboration with the local administration at the appropriate level, such as:

1. Establish demonstration fields / rural sanitation parks for exposure of various technology options available under SBM to the rural populace
2. Organise exhibitions / sanitation *melas*
3. Provide necessary exposure to the children in schools about proper sanitation and hygiene
4. Provide additional incentive to rural households in the form of suitable sanitary materials or create sanitation facilities for the rural populace through appropriate local organisation

³https://jalshakti-ddws.gov.in/sites/default/files/Framework_of_Engagement_with_Corporates.pdf

5. Provide community sanitary complexes, as may be the need
6. Provide assistance in effective SLWM technology and resources
7. Provide trained manpower for maintenance of sanitation facilities and / or SLWM assets
8. Propagate the programme through mass media and GP level interventions
9. Any other means to promote sanitation and hygiene as desired by the department

The DDWS has issued guidelines⁴ to facilitate the involvement of CSR resources in sanitation works. States can use these guidelines as a base to develop their own procedure to attract/receive and utilise CSR funds.

Allocation of CSR fund by CPSEs for Swachh Bharat activities A Group of Secretaries constituted for 'Swachh Bharat and Ganga Rejuvenation' has recommended for spending 33% of the CSR funds by Central Public Sector Enterprises (CPSEs) towards achieving goal of an ODF country. As per item no. (i) of Schedule VII of the Companies Act, 2013, CPSEs under their Corporate Social Responsibility

(CSR) policy may select several activities including sanitation, contribution to 'Swachh Bharat Kosh' set up by the Central Government.”(Ministry of Heavy Industries & Public Enterprises Ltr No.CSR-01 / 0003 / 2016-Dir(CSR), dated 01.08.2016)

Funds collected in the Swachh Bharat Kosh may also be directed towards activities supporting SBMG Phase-II.



⁴Guidelines for Corporate Social Responsibility (CSR) in sanitation are available at: https://swachhbharatmission.gov.in/sbmcms/writereaddata/Portal/Images/Guide_Line_Sanitation_CSR.pdf

13

RESEARCH & DEVELOPMENT



Department of Drinking Water and Sanitation will invest in research and development to ensure that state-of-the-art technologies, approaches, and methods are being used to implement SBMG Phase II activities. The Research and Development works at DDWS would involve, review of technologies and promotion of appropriate technologies, research towards ecologically safe disposal of human excreta, strengthening decentralized operation and management, use of ICT for programme effectiveness etc. States too are encouraged to invest in research and development with objectives of developing state of the art technology that can be operated and managed in a decentralized manner.

Collaboration with research institutions involved in the management of SLWM will be established and their research work supported. Crowdsourcing of ideas, organizing Hackathons etc. shall be encouraged towards acquiring the latest information, knowledge and

technology to achieve the objectives of the programme. The programme will continue encouraging the introduction of innovations and technologies in the field of toilet construction and SLWM.

A Research & Development Advisory Committee (RDAC) under the Chairpersonship of Joint / Additional Secretary, DDWS will work to promote research and development activities for the Sanitation. The major areas for Research and Development in sanitation include technological and programmatic areas. To further Research and Development in the technological and programmatic areas of sanitation including SLWM, 100% funding to research institutions/ organizations including NGOs will be given by the Central Government after submission of project proposals by such institutions/ organizations to DDWS and approval by RDAC.

To strengthen the R&D facilities in the concerned Departments in various States, State Governments

are encouraged to establish R&D cells with adequate manpower and infrastructure. R&D Cells are required to remain in touch with premier technical institutions within the State. The network of technical institutions may follow the guidelines issued by the Department from time to time for effective implementation of the rural sanitation programme. R&D Cells are also required to be in constant touch with the Monitoring and Investigation divisions and the

Monitoring and Evaluation Study Reports for initiating appropriate follow up action.

At the Government of India level, a Technical Committee has been set up headed by the Principal Scientific Adviser to the Prime Minister to consult for new technologies and innovations in the sector.



14

PLANNING FOR SBMG PHASE II

Swachh Bharat promotes decentralized planning where people collectively analyze their current situation, decide the improvement that they intend to achieve and accordingly identify intervention for achieving the desired levels of service and improvements. Planning under SBMG Phase II will be done at 3 levels:

14.1 Village Action Plan

Each Gram Panchayat will prepare “Village Action Plans” for all of its villages in a convergent manner for the SBMG and the Jal Jeevan Mission in a participatory manner, especially involving women and marginalized people, so that everyone could get equally benefitted from the implementation of the plan. The Village Action Plan would act as a resource for input into the GPDP, as well as for the subsequent formulation of the respective District Swachhata Plans.

The Plan will necessarily identify the following:

1. Number of new households that need to be supported for access to a toilet. The plan will identify whether the households will be supported through Individual Household Latrines or Community Sanitary Complexes.
2. Interventions that are needed to retrofit, upgrade / rejuvenate any dysfunctional toilet.
3. Interventions that will be implemented in partnership with JJM. This should match with interventions agreed in the Village Action Plan developed for implementation of Jal Jeevan Mission in the village
4. Hygiene promotion interventions to be taken in the year.
5. IEC and capacity building interventions needed in the year, their implementation plan, scheduling, staffing and funding
6. Location and number of assets for solid waste and liquid waste management.
7. Operation and maintenance arrangements including the source of funds for meeting annual operation and maintenance costs.
8. Involvement of the private sector, non-Government agencies for any part of work and terms and conditions for their engagement.
9. Details of activities that will be undertaken in each Revenue Village of the GP.
10. Allocation of budget for each of the activities and identification of funding source.



The GPs should prepare their Village Action Plan (VAP) for SBMG and JJM in a convergent manner. The Greywater management in villages should be planned in consonance with the piped water supply already provided to the villages/ planned to be provided under JJM or any other State's schemes. The VAP for SBMG and JJM should be part of their overall GPDP.

The plan should be presented in the Gram Sabha and endorsement of the Gram Sabha should be obtained and recorded. All Gram Panchayats/Blocks will develop the plans as per a date decided by the DWSC every year, from 2021 onwards.

14.2 District Swachhata Plan

As had been done in SBMG Phase I, each district will prepare a District Swachhata Plan after consolidating Village Action Plans of its GPs and incorporating the interventions to be taken up at Block and District levels for the implementation of Phase II. The District Swachhata Plan would include the following:

1. Number of new households to be supported for access to safe sanitation. This would be extrapolated from Village Action Plans.
2. Key IEC interventions that will be used to ensure sustainability, behaviour change and implementation and use of SLWM assets in villages - their funding,

messaging, staffing, media planning and scheduling

3. Key capacity building trainings, staffing for trainers, and schedule for training.
4. Number and schedule for construction of Plastic Waste Management Units every year.
5. Schedule for implementation of FSM in the District.
6. Number and type of infrastructure to be created in villages selected for the year for biodegradable solid waste management.
7. Number and type of infrastructure to be created in villages selected for the year for greywater management.
8. Convergence mechanism established to ensure leveraging of funds from FC, MNREGS etc. to fully finance the interventions.
9. Monitoring, Reporting and Evaluation arrangements.

All Districts will develop the plan as per a date decided by the SWSC every year, from 2020-21 onwards, and upload it on the IMIS after obtaining approval of the State Government.

14.3 State Planning

State Governments and UTs would develop a Project Implementation Plan and Annual Implementation Plans every year consolidating the District Swachhata Plans to achieve the objectives of SBMG Phase II.

14.3.1 Project Implementation Plan (PIP)

All States/UTs shall prepare Project Implementation Plans (PIP) under SBMG phase II for the entire period of the programme from 2020-21 to 2024-25 based on all the sanitation activities to be taken up in the villages, Blocks and districts. Project Implementation Plan shall be developed in consultation with Districts and shall identify any special challenges, risks, issues in any District(s) that need special attention. The PIP shall specifically include the activities to be taken up from SBMG and 15th Finance Commission grants as per the prescribed funding norms under the programme. The States/UTs shall submit the PIPs to DDWS after getting approval from the State Level Scheme Sanctioning Committee (SLSSC). The PIPs will then be considered and approved by NSSC. Based on the actual requirements, the PIPs can be revised by the States/UTs during the programme period with proper justification that is acceptable to

DDWS, and only after obtaining approval of NSSC.

14.3.2 Annual Implementation Plan (AIP)

GPs shall prepare their Village Action Plans (VAP) for all the sanitation activities (including activities to be taken up from SBMG as well as 15th Finance Commission Grants) and shall include them in their Gram Panchayat Development Plan (GPDP). An annual plan shall be prepared by the District, incorporating VAP and the activities to be taken up at Block and district level. It will be further consolidated by the State Government into a State Plan. While preparing the plans for various activities, the funding sources for each activity shall be identified and clearly brought out in the AIP. An Annual Communication Plan should also be included in the AIP of all States. Based on formative research and consultation rounds, the State shall develop a tailor-made Communication Strategy, a Communication Plan, and material, and will train community mobilisers to use these tools. IEC and Capacity Building interventions needed in the year will be included in this.

The plans also require to be entered in the IMIS of DDWS. The State Plan needs to be shared with the DDWS in the illustrative proforma

provided to the States by DDWS before the commencement of the financial year based on the balance works to be completed. There shall be a Plan Appraisal Committee (PAC) in DDWS, chaired by the Additional / Joint Secretary in charge of SBMG, with Principal Secretary i/c of rural sanitation of the relevant State, the State SBMG Coordinator and the Director / Deputy Secretary (SBMG) in DDWS as members. The proposed AIPs shall be discussed by the PAC and finalized with or without suggestions/modifications.

The final AIP shall be prepared by the States and forwarded to the DDWS within a fortnight of the discussions in the PAC. Then the AIPs shall be considered and approved by the NSSC each year.

All States will develop the plan by the 1st of March every year, and upload it on the website of IMIS. The State may accordingly establish dates for the completion of the District and Village Action Plans at their respective levels.



15

FINANCIAL PLANNING AND PROGRAMME FUNDING



For successful implementation of SBMG, robust financial planning, timely funding, mobilization of adequate resources and prudent utilization of funds are some of the key factors. In this direction, the SWSM / DWSM will prepare year-wise financial plan by pooling all the available resources for rural sanitation like the Central fund, State fund, 15th FC grants to RLBs, funds available under MGNREGS and other schemes of Central/State Governments, MPLADS, MLALADS, CSR fund, business models/PPP, etc. Central financial assistance for SBMG will be released by DDWS from its budgetary allocation and/or extra budgetary resources, as the case may be, considering various factors.

SBMG is a Centrally Sponsored Scheme with fund sharing pattern between Centre and States being 90:10 for North-Eastern States, Himachal Pradesh, Uttarakhand and UT of Jammu and Kashmir, 100% from Centre for remaining Union Territories

(UTs), and 60:40 for other States. While corresponding funding share is available from Government of India, it is important that States and Districts undertake financial planning to ensure that all credible plans of Districts and Gram Panchayats can be funded and that there is enough resource allocated for all components of the programme.

States shall proactively engage and involve Public Health Engineering Department, Panchayati Raj Department and Rural Development Department apart from other related departments to ensure coordinated implementation and co-financing of the programme. These Departments shall also instruct and support their District units to ensure that planning, implementation and financing is well coordinated. Executive Orders, if necessary, will be issued by State Governments to Districts, Blocks and Gram Panchayats to achieve integrated and coordinated implementation.

15.1 Programme funding Provisions in SBMG Phase II

The various components and approved financial assistance for different components under SBMG Phase-II are as below:

Components		Financial assistance		
Incentive for construction of IHHLs <i>(BPLs and Identified APLs)</i>		Upto Rs. 12,000 / - <i>(including provision for water storage facility for handwashing and cleaning to maintain hygiene)</i>		
SLWM activities	Village level SLWM activities	Village size	Financial support	
		Upto 5000 population	Solid Waste Management: Upto Rs.60 per capita Greywater Management: Upto Rs.280 per capita	
		Above 5000 population	Solid Waste Management: Upto Rs.45 per capita Greywater Management: Upto Rs.660 per capita	
		Note-		
	1. 30% of this amount will be borne by the GPs from their 15th Finance Commission grants. 2. Each village can utilize a minimum of total Rs. 1 lakh based on their requirements for both solid waste and greywater management.			
	District level SLWM activities	Plastic Waste Management Unit <i>(one in each Block)</i>	Upto Rs.16 lakh per unit	
Faecal Sludge Management (FSM)		Upto Rs.230 per capita		
GOBAR-Dhan Projects		Upto Rs.50 lakh per District		
Community Sanitary Complex (CSC)		Rs. 3 Lakh <i>Note: 30% of this will be borne by GPs from 15th FC</i>		
IEC and Capacity Building		Up to 5% of the total funding for programmatic components <i>(up to 3% to be used at State / District levels and up to 2% at Central level)</i>		
Administrative Expenses		Up to 1% of the total funding for programmatic components		
Revolving Fund		Up to 5% of Project outlay <i>subject to max. Rs. 1.5 crore per district</i>		
Flexi Funds		The States can use flexi funds as per Ministry of Finance guidelines issued in this regard from time to time for innovations / technology options at the State level to meet the local needs and requirements within the overall objective of the Scheme.		

State / UT Governments will have the flexibility to provide higher incentive / additional funding from other sources such as 15th Finance Commission grants, MPLAD / MLALAD / CSR funds or through convergence with MGNREGS or other schemes of the State or Central Governments, etc.

15.2 Financial Provisions explained

Incentive for IHHL The beneficiary is to be encouraged to contribute in the construction of his/her IHHL to promote ownership. The beneficiary may also be encouraged to voluntarily surrender his/her incentive. State Governments also have the flexibility to provide higher incentive for a household toilet, for higher unit costs from their own funds, if necessary. Ideally, the construction activities should be taken up by the individual beneficiaries themselves with support from/or through agencies in the village. States may decide to provide incentive to households in one or more phases at different stages of construction and usage. DBT shall be ensured for payment of incentive.

Community Sanitary Complex (CSC)

Financial assistance up to Rs.3 lakh per CSC will be provided to the GPs for construction of CSCs at village level. 30% of this amount will be borne by the GPs from their 15th Finance Commission grants, and remaining 70% will be provided from SBMG Phase-II funds. However, emphasis is to be given to PPP mode for setting up of such projects. The GP will decide upon a suitable location for construction of CSC that is easily accessible to all, having adequate water availability and where long-term O&M is ensured. For the construction of CSC, priority shall be given to the locations with predominant SC / ST habitations, poorest of poor in the village and/or those visited by migrant labourers / floating population etc.

Solid and Liquid Waste Management (SLWM)

SLWM may include a large number of activities, however the funding under SBMG is allowed only for the major activities given below:

(i) Purchase of tri-cycles/battery vehicles for transportation of wastes from households to village level collection/ segregation/ storage centre

(ii) **Organic Waste**

- (a) Construction of community compost pits at village level
- (b) GOBAR-Dhan Projects at district level

(Labour cost of construction of compost pits may be borne through convergence with MGNREGS or any other funding source)

(iii) **Plastic Waste**

- (a) Storage Facility at village level
- (b) Plastic Waste Management Unit at Block/District level

(iv) **Greywater Management**

- (a) Construction of community soak pits (in smaller villages i.e. upto 5000 population). Greywater management system such as WSP or any other technologies, etc. can also be taken up with the additional fund support from 15th Finance Commission grants or through convergence with other Central/State Governments schemes.

(b) In bigger villages (i.e. above 5000 population), apart from community soak pits, greywater management system such as WSP or any other technologies, etc. can also be taken up.

(Labour cost of construction of soak pits and greywater systems will be borne through convergence with MGNREGS or any other funding source)

(Drainage channels (drainage of greywater from household up to the disposal or management) have to be provided by the GPs with their 15th Finance Commission grants and/or through convergence with MGNREGS or other schemes of State or Central Governments.)

- (v) **Faecal Sludge Management (FSM)** FSM shall be taken up at district level for cluster of villages for single pit and septic tank toilets. Funding for FSM under SBMG can be utilized only for Trenching, Drying Beds and FSMPs or any other technology, where retrofitting or co-treatment is not possible.

(Emptying of faecal sludge from septic tanks/single pits and its transport may be taken up through appropriate business models or/and with the 15th Finance Commission grants to GPs or/and through convergence with other schemes of State or Central Governments.)

Information, Education and Communication (IEC) and Capacity Building (CB) Up to 5% of the total funding for programmatic components can be spent on IEC and capacity strengthening. Out of this, *up to 3% can be used at State/District levels and up to 2% at Central level.* Capacity strengthening will be given emphasis vis a vis IEC. *At the Central (DDWS) level, various activities related to M&E, MIS, R&D and engagement of Programme Management Consultancy, technical manpower etc. will be taken up from the funds earmarked for Central level IEC activities.*

Administrative Charges Up to 1% of the total funding for programmatic components can be spent under Administrative charges. The Administrative charges shall normally permit expenditure on salary of outsourced / contractual staff / consultants and agencies deployed for the execution of various components of the SBMG at State, District, Block and GP levels, support services, fuel charges, vehicle hire charges, stationery, monitoring & evaluation activities, TA/DA to Inter-State and Inter-District Survey teams deputed for monitoring and verification, exposure visits. The following items of expenses are specifically prohibited under "administrative expenses":

- a. Purchase of vehicles
- b. Purchase of land and buildings
- c. Construction of official buildings and rest houses (this excludes toilet units needed for SBMG projects)

- d. Expenses for any political party and religious organisations
- e. Expenses for gifts and donations
- f. Temporary transfer of funds to any other scheme or fund in the State.

Revolving Fund A Revolving Fund will be available at the district level out of the SBMG funds. The Revolving fund may be given to Societies, Self Help Groups or other groups as decided by the States, whose creditworthiness is established, for providing cheap finance to their members for the construction of toilets. Loan from this fund should be recovered in 12-18 installments. States will have the flexibility to decide the other terms and conditions for sanction of the Revolving fund.

This Revolving Fund can be accessed by APL households not covered for incentives under the guidelines. Households which have availed incentives under any sanitation scheme earlier can also access such finance as loans. Those households (BPL and APL) covered under the incentive can also approach for financing under the Revolving Fund to meet the additional cost of improved toilets with bathing facility. Registered SHGs with proven credentials can approach the DWSM for such funding. Upto 5% of the district project outlay subject to maximum of Rs. 1.50 crore, can be used as Revolving Fund, including funding for setting up of RSMs/PCs. Provision of the Revolving Fund in a district shall be approved by the DWSM/DWSC.



16

RELEASE OF FUNDS



The SBMG Phase II shall support all States and Union Territories of India. Funds will be released to States/UTs based on their performance and ability to achieve programme results. States shall become eligible to release funds based on attainment of the following conditions:

1. The State Cabinet passes a resolution to implement the SBMG Phase II and commits timely release of State share for the programme
2. The State has set up suggested institutional arrangement for implementation and management of SBMG Phase II components
3. Agrees to devolve funds to Gram Panchayats for co-financing of SBMG components
4. Develops a Project Implementation Plan and Annual Implementation Plans

16.1 Release from Centre to State level implementing body

The funds under SBMG will be released electronically by DDWS to the State Governments as per instructions issued by the Ministry of Finance from time to time. The State Governments shall release the funds to the SSBMG within 15 days of transfer of funds from DDWS along with matching State share. In case of advance State share is released by the State Governments, the same can be adjusted against the Centre share released in the subsequent year(s).

Funds under SBMG will be released to the State / UTs only after the respective Government provides the undertaking that funds earmarked under 15th Finance Commission grants for sanitation activities are being devolved to rural local bodies.

The States/UTs will operate a single savings bank account in any Scheduled Commercial Bank (except foreign banks) or a bank authorized by the State Government for receipt of SBMG funds and all transactions relating to SBMG including Central share, State share, or any other receipt. All the existing accounts for SBMG at District / Block / GP levels will be closed after

transferring the unspent balance of those accounts to the State nodal account. The details of the SSBMG nodal bank account have to be communicated to DDWS along with the name of the bank, IFSC Code and Account Number, etc. and should not be changed during the implementation of the project without prior permission of the DDWS. The States/UTs may use the existing account at their SSBMG level as nodal account. The funds release / advance / transfer / expenditure under the programme at all levels shall be mandatory through the Public Financial Management System (PFMS) of Government of India.

Based on approved demand of States as decided in the AIP every year and the availability of funds at the national level, a tentative allocation to all the States will be worked out with the approval of the Secretary, DDWS and the Financial Advisor, DDWS, for release of funds in two equal installments. Each installment will be released in two tranches. Concurrence of Integrated Finance Division of DDWS will be obtained for release of installments as a whole for all eligible States/UTs and thereafter Department will release the fund in tranches after assessing the utilization of fund by the States / UTs. Thus, releases are

planned in consonance with 'Just In Time' principle of Ministry of Finance to avoid any undue parking of fund.

Based on the approved tentative allocation of the States and subject to fulfillment of the requisite conditionalities, funds will be released with the approval of Joint Secretary / Additional Secretary in-charge of SBMG and concurrence of Integrated Finance Division of DDWS.

All the implementing agencies and below level agencies in the States / UTs will be registered in PFMS as parent-child agency and shall be mapped with Linked State scheme code for SBMG and to the State nodal account - it is also to be ensured that all the transactions shall be mandatorily made in PFMS.

Non-compliance of the above condition will affect the future release of Gol share under the programme.

The release of funds to the States/UTs would be further subject to the extant instructions of Government of India.

Utilization of funds and unspent balance will be monitored through the PFMS for the purpose of release of funds to the States / UTs.

16.1.1 Release of 1st installment

The eligibility of the State / UT for release of 1st installment (i.e. 50% of tentative allocation) shall be calculated after reducing the amount of opening balance / unspent balance in excess of 10% of the previous year's release to the State/UT (in case no fund was released during the previous year, the funds released to the State/UT during preceding year to the previous year shall be considered for calculating 10%), from the amount of first installment. The amount for which sanction order issued in the month of March last year will not be taken into consideration while subsuming in the excess OB.

The full amount of 1st installment will be released in two tranches. The 1st tranche will be 50% of the eligible amount of 1st installment after subsuming the excess opening balance / unspent balance and will be released as and when the complete formal proposal seeking release of 1st installment with requisite documents, including Final UC and ASA, which became due during the previous financial year, will be submitted by the State and concurred by IFD, Gol. However, the IFD's concurrence will be obtained for full 50% amount of 1st installment. The 2nd tranche i.e. 50% of the eligible amount of 1st installment after subsuming the excess opening balance / unspent

balance and balance part of 1st installment i.e. the subsumed amount of excess opening balance/ unspent balance, if any, will be released after utilization of 80% of the available funds during the current financial year i.e. opening balance, funds released as 1st tranche of 1st installment and interest accrued thereon, automatically by the Department (i.e. without any proposal and reference to IFD).

16.1.2 Release of 2nd installment

The 2nd installment of funds, as per the tentative allocation, will also be released in two tranches on fulfillment of the following conditions:

- i) Receipt of a specific proposal from the State / UT;
- ii) Annual Performance Report as required by DDWS. This may include elements of State's performance in SSG, findings of annual verification exercise and other metrics as decided from time to time;
- iii) Statement of achievements of monthly / quarterly progress against the targets specified in the AIP as required by DDWS from time to time;
- iv) Commitment of the State to release of proportionate State share into the SWSM account within fifteen days of release of Central share;
- v) Utilization of 60% of the available funds with the SWSM

i.e. opening balance, funds released as first installment of Grant-in-aid under SBMG during the year and interest earned thereon, Central Share and State Share separately;

- vi) Analysis of the funds absorbing capacity of the State (maximum six months requirement based on average expenditure trend during the past two months),
- vii) Submission of Audited Statements of Accounts of the preceding financial year as per Annexure – IX
- viii) Submission of Final Utilization Certificates for the preceding financial year for Central and State Share separately in the prescribed Proforma as per Annexure-X duly signed by the Secretary in-charge of SBMG;
- ix) Any other condition(s) that may be specified by the Central Government from time to time.

The 1st tranche will be 50% of the 2nd installment and will be released on receipt of proposal for 2nd installment

and fulfillment of the above conditions by the State/UT and concurrence of IFD, Gol. However, the IFD's concurrence will be obtained for full amount of 2nd installment. The 2nd tranche i.e. remaining 50% of the 2nd installment will be released after utilization of 80% of the available funds during the current financial year i.e. opening balance, funds released during the current financial year (full 1st installment and 1st tranche of 2nd installment) and interest accrued thereon, for both Centre and State share, automatically by the Department i.e. without any proposal and reference to IFD).

In case the Audited Statement of Accounts and Utilization Certificates for the preceding financial year is not submitted by the State / UT, up to 75% of the tentative allocation will be considered for release on receipt of specific proposal with proper justification and on fulfillment of other conditions for release of 2nd installment.



16.2 Release of additional funds to incentivize better performing States

The funds will be released to States based on their performance and in challenge mode after analyzing the results achieved and funds absorbing capacity of the States. The last date for submission of complete documents for the funds release as per tentative allocation will be 15th February of the financial year. Thereafter, the balance funds of the State(s) will be released to the better performing States after revising their allocation with the approval of the Secretary, DDWS

based on their work plan and subject to utilization of 75% of the available funds during the year.

16.3 Interest earned on Funds Released

The SBMG funds (Central and State shares) should be kept in savings bank account(s) only. The interest accrued on SBMG funds shall be treated as part of the SBMG resource. The State must submit utilization of interest accrued on SBMG funds along with claim/s for subsequent instalments and it should be reflected in the Utilization Certificates.



17

MONITORING & EVALUATION



DDWS, at the Central level, shall lead the monitoring and evaluation function in coordination with States and Districts. Under SBMG Phase II, effective monitoring of outcomes will be undertaken to ensure ODF Plus villages. The monitoring of outputs will also be done for administrative purposes such as the monitoring of expenditure and assets created. The monitoring framework should be able to identify the following:

1. Whether adequate IEC activities have been carried out for behaviour change
2. Whether the ODF status of villages has been achieved and is being sustained

3. Whether adequate solid waste management has been ensured
4. Whether adequate liquid waste management has been ensured
5. Whether the village is visually clean

The monitoring and evaluation activities shall be oriented towards monitoring attainment of programme results, effectively and efficiently. Monitoring will also include undertaking independent assessments, periodic reviews, field visits and thematic consultations to ascertain programme progress and effectiveness.

17.1 Output Outcome Monitoring Framework

SBMG Phase II will monitor progress on outputs and outcomes using an Output-Outcome Monitoring Framework. Outputs refer to the direct and measurable product of the program activities, often expressed in physical terms or unit. Outcomes are the collective results or qualitative improvements brought about in the delivery of these services. The suggested output outcome monitoring framework for SBMG is as under:-

Parameter	Output	Outcome
ODF Sustainability	<ul style="list-style-type: none"> a. No of IHHLs constructed b. No. of Community Sanitary Complexes (CSCs) constructed 	<ul style="list-style-type: none"> a. Percentage of rural HH having access to toilets and using them regularly b. Percentage of villages confirming ODF status
Improvement in cleanliness of villages	<ul style="list-style-type: none"> a. No. of villages covered with solid waste management b. No. of villages covered with Greywater management c. No. of Blocks with plastic waste management units d. No. of districts covered with Faecal Sludge Management (FSM) arrangements 	<ul style="list-style-type: none"> a. Percentage of villages having minimal littering b. Percentage of villages having minimal stagnation of waste water

The Output and Outcome indicators may be changed during the programme period according to needs.



17.2 Integrated Management Information System

SBMG Phase II will have a comprehensive online Integrated Management Information System (IMIS) that will provide regular and customized information to programme managers for decision support. SBMG Phase II shall generate integrated management information using data entered directly by State Governments as well as information to be received, from time to time, from the Ministry of Panchayati Raj and the Department of Rural Development. In the IMIS, all SBMG activities viz. construction of Individual and Community / Household Toilets, SLWM infrastructure, IEC, Capacity Building and administration related activities, including financial progress, will be exclusively captured in IMIS of SBMG. The other Non-SBMG funded activities will be extracted from the funding programme's MIS and presented in IMIS for analysis.

The IMIS will have modules to capture plans at GP, Block and District level and provide information on status of planning and its implementation. All States/UTs are to submit their physical and financial progress reports of the implementation of the Programme, in real time through the online IMIS using user-ids and passwords provided to various implementing agencies of the States/UTs. It is recommended that all IMIS entries may be made at the Block level by designated data entry operators, while only necessary approvals may be undertaken at the district levels.

All activity-wise physical and financial progress is to be updated in the SBMG IMIS in real time. All approvals for any data entry in the MIS to be made by the district must be completed within 5 days of entry at the Block level, and all approvals for any data entry in the MIS to be made by the State must be completed within 10 days of entry at the district level.

17.3 Baseline Survey

The baseline for the programme on ODF Plus parameters must be determined to ensure the effective planning and implementation of the programme. States and UTs will undertake a baseline assessment in FY 2020-21 to determine initial coverage on key components under SBMG for all villages by August 31, 2020, with the assistance from District/Block Coordinators/Swachhagrahis. Under the baseline, all community and individual SLWM assets constructed as of 31st May 2020 from various Central/ State/other schemes / self-funded would be reported through the mobile app or any other appropriate mechanisms. Details for undertaking the baseline exercise shall be shared by DDWS.

17.4 Geotagging of assets

All assets constructed under the programme and reported on the SBMG IMIS shall invariably be geo-tagged. Protocols and mobile applications developed for the geotagging of SBMG Phase I assets shall continue to remain valid with appropriate modifications and improvisations.

17.5 Declaration and verification of ODF Plus villages

There shall be concurrent monitoring of the quality of implementation of the programme, as follows:

(i) ODF Plus declaration

A village that has met all the ODF Plus criteria will self-declare themselves ODF Plus at a Gram Sabha meeting. Within 30 days of the above declaration, a due diligence team from the Block will review the ODF sustainability and SLWM arrangements in the village, after which the team will ensure declaration of the village as ODF Plus on the IMIS. The declaration of ODF Plus on the IMIS, thus, shall be made at the Block level. The resolution passed at the Gram Sabha to declare the village ODF Plus shall be recorded in the form of a certificate duly signed by the Sarpanch and the Panchayat Secretary. The format for the ODF Plus declaration certificate is attached at Annexure – XI.

(ii) ODF Plus verification by districts

The District must ensure mandatory third-party verification of a village, covering all households in the village, **within 90 days of ODF Plus declaration for the first time, and thereafter** to be undertaken on annual basis. A list of indicators to assess for ODF Plus verification at the household and village level, along with the suggested protocol, is attached at Annexure - XII. The recording of verification of ODF Plus on the IMIS, thus, shall be made at the district level.

The Districts may constitute verification teams of District/ Block officials or non-Government volunteers. While voluntary teams are preferred, districts may also engage third party agencies for this verification. The teams will have to be appropriately trained to understand ODF Plus definition. The community may be involved during the process of verification as well.

As part of the first verification, each district must upload an ODF Plus certificate duly signed by the District Collector confirming the ODF Plus status of the district. A base format for the same is attached at Annexure - XIII.

(iii) ODF Plus verification by States/UTs

While the districts undertake a 100% verification of ODF Plus villages every year, State teams shall undertake a sample verification which covers at least 5% of all households in each village, on an annual basis. The States may verify the villages against the same indicators as those for the district verification of ODF Plus villages. The sample verification of ODF Plus on the IMIS, thus, shall be made at the State level.

Meanwhile, the Swachh Bharat Mission (Grameen) at the national level, State level and district level will have dedicated monitoring teams that shall be responsible for monitoring the Mission activities, which shall include field level monitoring.

Use of independent agencies / CSOs / NGOs for the concurrent monitoring of the programme is permitted. Central and State Missions may engage agencies with experience and presence

in the States in question for monitoring activities. At the State level, up to 5% of the permissible expenditure of the Administrative Component may be utilized for M&E activities.

17.6 Annual monitoring through 'Swachh Survekshan Grameen - SSG'

Department of Drinking Water and Sanitation would commission Swachh Survekshan Grameen (SSG) every year to verify results claimed by States and Districts and rank them on key ODF Plus parameters. An Independent Verification Agency (IVA) with requisite experience and expertise would be hired nationally to assess the implementation of ODF Plus elements and seek feedback from citizens on the overall cleanliness in villages. Best performing States and Districts will be awarded every year in a special function organized for the same. Key parameters for assessment under Swachh Survekshan Grameen may include:

- Assessment of sanitation status in villages and key public places
- Verification of ODF plus progress claimed by States and Districts
- Citizens feedback on sanitation status in Villages

17.7 Social Audit

Social Audit meeting will be held in each GP once in six months. The GP will organise and assist in organizing Social Audits of the programme. The District and the Block shall be responsible to ensure that this schedule is adhered to. Manual on Social Audit issued from time to time by the DDWS may be referred to for use of social audit for community engagement and monitoring under SBMG.

17.8 Programme Evaluation

States/UTs may conduct periodical evaluation studies on the implementation of Phase II of SBMG. These evaluations could be used for course correction and improving the efficiency and effectiveness of the programme. Evaluation studies may be conducted through reputed institutions and organizations decided by the State and copies of the reports should be furnished to the Government of India. Remedial action should be taken by the States/UTs based on these evaluation studies. The cost of such studies can be charged to the Administrative Charges component of SBMG.

At the Central level, the performance of the States under the Mission shall be evaluated from time to time through agencies of repute.

18

ANNUAL AUDIT



All audit requirements of the Government of India and the Comptroller and Auditor General (CAG) of India as decided from time to time will be followed. States will ensure that the accounts are audited by a Chartered Accountant selected from a panel approved by the CAG, within six months of the close of the financial year in accordance with the General Financial Rules of the

Government of India and the audited statement of accounts is submitted to the Department of Drinking Water and Sanitation. The template for submitting audit reports is placed as Annexure – IX.



Technological details for Individual Household Latrines and Community Sanitary Complexes

1. Individual Household Latrines in Rural Areas

Safe management of excreta is one of the components of Sanitation. WHO observed that one gram of faeces can contain 10,000,000 viruses, 1,000,000 bacteria, 1,000 parasite cysts and 100 parasite eggs. Open and untreated human excreta can interact with food through soil, water and crops unless this fecal-oral route is broken through adopting safe sanitation and hygiene practices. Having a toilet of appropriate design ensuring usage, and adequate arrangements for the safe management of waste arising from households can help assure health, wealth and self-esteem.

Achieving open defecation free communities is the essence of Swachh Bharat Mission Grameen (SBMG). This shall mean households and community/ public institutions shall use safe technology for disposal of faeces. Under SBMG, a duly completed household sanitary latrine comprises of:

- i) A sub-structure that safely confines human faeces and eliminates the need for handling by humans before it is fully decomposed
- ii) A super structure, with provision for water storage for flushing and hand wash

An ideal Latrine/ Toilet

Irrespective of technical type, an ideal toilet should have the following characteristics

- It should be affordable
- It should require less water
- It should require less space
- It should be free from odour and vector nuisance
- It should be able to safeguard the health
- It should be able to convert excreta into manure
- It should be easy to operate and maintain
- It should have a long life



Safe technology is the key to ensuring ODF sustainability. Therefore, a technology that is affordable, geographically viable, easy to maintain, treats waste on-site is the operative factor for rural India.

Selection of the right type of toilet from various options

There are several types of toilets world over. Most of these are designed as per the requirements of the local people, geophysical and geo-hydrological conditions of the region, environmental factors, economic status and cultural habits of the people etc. Hence a particular toilet-type cannot be recommended for the whole of a country or even for an entire state.

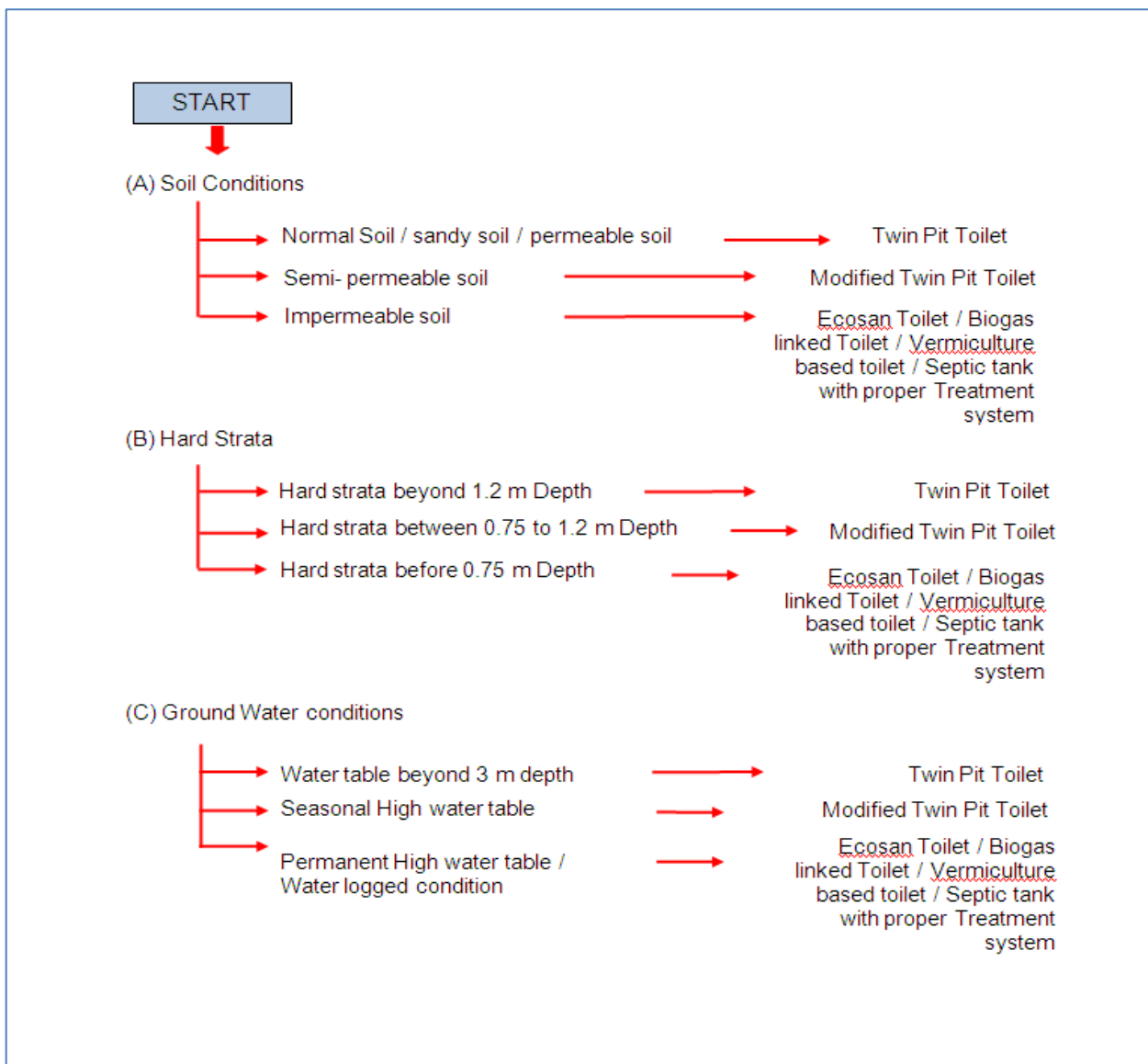

Selection Criteria

In view of sustainability, Swachh Bharat Mission (G) promotes **Twin-leach Pit Pour Flush Water Seal toilets** at household and community level where the ground water level is below 3m depth, and soil condition is normal/sandy/permeable/hard strata beyond 1.2 m depth.

Precautions that to be taken while selecting the site for Twin Pit Toilet

First, look at the convenience of the users. Remember that open defecation is generally practised away from the human habitations. Using a closed toilet, that too in the backyard is a major shift in habits for many. Hence select a site to suit their convenience. However, taking into consideration the mode of functioning and structure of twin pit toilet, following points are technically very important and need to be followed scrupulously.

1. Do not select a low-lying place where there is a chance of water stagnation. This will hamper the leaching of water from leach pits. Instead, select a place at a little higher elevation.
2. A safe distance from a drinking source like a hand pump, well, river, pond etc. (except secured piped water supply) is very important. There is continuous leaching of water from the leach pit into the nearby ground and if there is a ground water source in vicinity, there is every possibility of its getting contaminated. To avoid this, a certain safe distance needs to be maintained.
3. Twin Pit Toilet should also be located away from a big tree; otherwise, the roots of the tree enter the leach pit and may crack the walls.
4. Twin Pit Toilet can be constructed near or even inside the house. However, in such case a safe distance of 2 to 3 ft. should be kept between leach pit and the house wall.
5. Rocky terrain is not suitable for a twin pit toilet. However, if a rock is struck below two and a half feet; twin pit toilet can be constructed with certain modifications.

Households are to be informed of the technological options, constraints and benefits and election of sanitation technology and material is the choice of the individuals



Basic components of Twin Pit Toilet

It is low-cost, requires less space and less water, the pit emptying is easy and the manure from the pit can be used for agriculture.

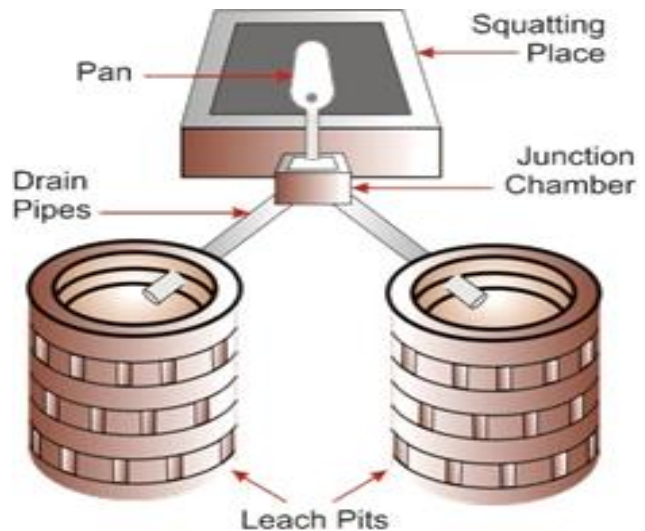

How does a Twin Pit Toilet Function?

The excreta deposited in the toilet pan reaches the junction chamber through the water seal trap. The junction chamber is connected to two underground leach pits by two separate drain pipes. However, the opening of one of the pipes is sealed with a plug of brick. This facilitates the flow of excreta to the active leach pit and only one pit gets filled at a time.

The bottom of the leach pit is not cemented. Also, the brick lining of the pit is done in a honeycomb fashion. The liquids from excreta get leached into the soil through the bottom and the holes in pit lining. The solid part of excreta remains in the pit which undergoes bacterial decomposition and gets converted into good quality manure in due course of time.

Ideally, pit size should be of 1m X 1m and distance between pits should be at least 1m to avoid cross-contamination.

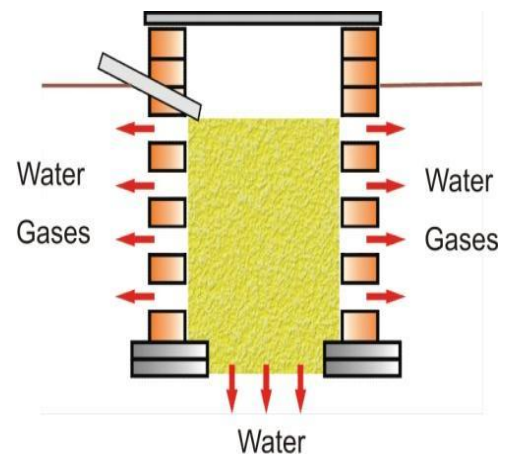

Essential components of Twin Pit Toilet

1. Honeycombing in leach pits

First layer 9" wide. Rest all layers in single brick masonry. Honeycombing to be done in alternate layers up to pipe level. Layers above the pipe to be done without honeycombing.



The first layer in 9" Brickwork



Upper layers in single brick with honeycombing in alternate layers

2. Pipe

100 mm PVC pipes should be used. The pipe should have a gradient of 1 in 10. Avoid using bends to ensure smooth flow of excreta with minimum water



The pipe should have adequate slope



Do not use bends

3. Junction Chamber

This is a specialized structure for diverting the flow of excreta from one pit to another.

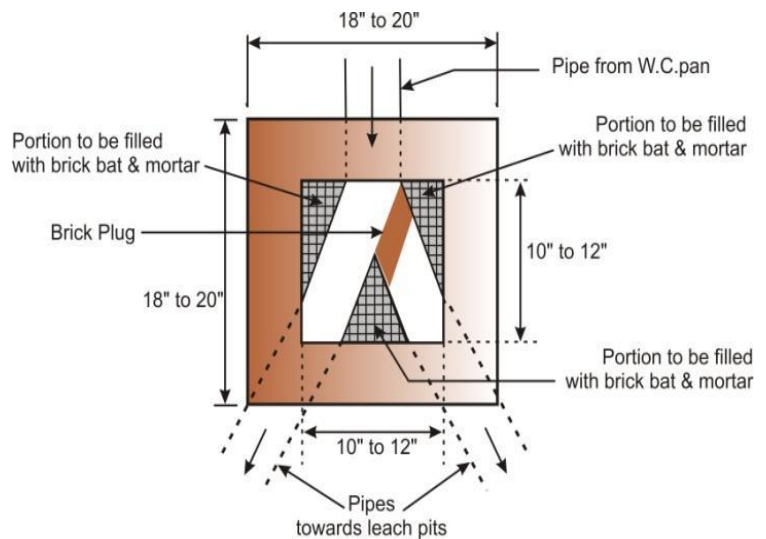

4. Water seal trap

20 mm water seal should be used. This ensures minimum use of water.

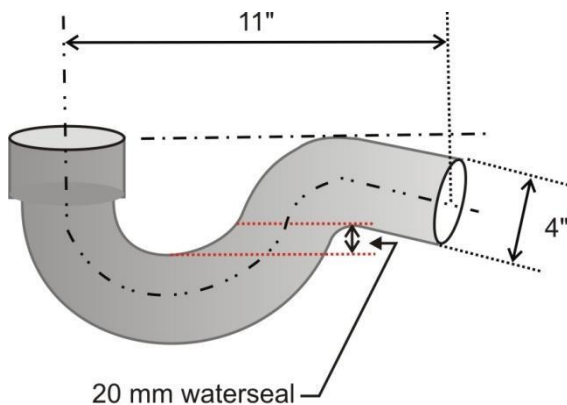

5. Water Closet pan

Pan with steep gradient should be used. **Rural Pan with a gradient of 25° to 30°** ensures minimum use of water.



Pan having less slope



Rural pan with adequate slope

6. Vent pipe

A vent pipe is **not required** in twin pit toilet since little if any obnoxious gases are generated in the leach pit and even that generated is absorbed in the surrounding soil through honeycombing.

7. Covering for Leach Pits

The Leach pits need to be covered with suitable covers. One of the following types of pit covers can be used.

1) Flagstones- Good quality Shahabad tiles or Cudappa stones can be conveniently used as pit covers. Four stones of 4 ft x 2 ft each are required per toilet. The minimum thickness of these stones should be 1.5 inches.

2) Properly cast and cured Reinforced Cement Concrete (RCC) or ferrocement slabs can also be used to cover the leach pits. These covers should be cast in two pieces for convenience of handling.



Emptying of filled pit

One pit gets filled within a period of 3 to 5 years, after which the brick plug in the junction chamber is changed to divert the flow of excreta to the other pit. The second pit also takes 3 to 5 years to fill. The solid accumulated in the pit undergoes decomposition and is converted to manure. This can be removed after a rest period of about one / two year and used in the fields after composting.

The manure has the following characteristics

1. It does not contain any active pathogens
2. It is almost dry and easily crumbled consistency
3. It does not emit any foul odour.



Due to these characteristics, removal of manure can be conveniently done without any harm and the same can be used in any field crop or home garden.

Illustration showing safe distance of drinking water source and twin pit toilet, septic tank toilet with soak pit for safe disposal of effluent



Toilet Facilities for Divyang

The Swachh Bharat Mission (G) promotes accessible toilets for Divyang. Depending on the type of disability, type of toilet facility and needs of the user, the toilet may require some additional modifications.

Making facilities physically accessible

A. Reaching the toilet facilities are :

- paths
- ramps
- support rails
- landmarks for blind people

B. Facilities inside the Toilet are:

- wide entrance
- flat platform in front of the door
- doors with strings
- easy to close, lockable for privacy



C. Usability:

- internal dimensions - extra space for a wheelchair to enter and turn, user +helper, or to move a seat to one side
 - support rails: fixed to the floor, adjustable height, movable frame, rope suspended from a beam
 - seating – fixed, movable
 - design of equipment
 - adapted water lifting mechanism
- The doorway should have a clear width of 900mm for a person using a wheelchair or those using assistants to get through. The door should generally open outside. Sliding doors are the most preferable.
 - A distance of 450mm to 600mm beside and beyond the leading edge of the door and a safe landing space of 1200mm X 1200mm in front for a wheelchair user to manoeuvre.
 - Door Handles should be fixed between 650 to 1100mm above the floor level. It should be preferably Lever shaped or D type handle.
 - A 150mm long handle may be fixed on the outside. The threshold of the toilet door should be at the same level without any steps. No door seal or other trip hazard should be there.



2. COMMUNITY SANITARY COMPLEXES IN RURAL AREAS

The provision of sanitation facilities through public toilet complexes is the most suitable option for those who cannot afford individual toilets for monetary reasons or due to lack of space and opt for open defecation. Such complexes are a useful and valuable option at public places, markets, taxi stands, etc., where a large congregation of people takes place. The Community Sanitary Complex (CSC) fosters the cognitive development of healthy sanitation practices in the community.

A community sanitary complex is an infrastructure for the use of the community and/or floating population. A Community Sanitary Complex takes care of safe disposal/reuse of human waste in addition to the objective of providing a toilet facility that enhances privacy and dignity.

Construction of CSCs shall happen at the site identified and approved by Gram Sabha. Community toilets should be ideally undertaken in SC/ST habitations where there could be challenges of building Individual Household Toilets. This CSCs will also cater to the needs of migrant labourers, large congregations in melas/ tourist places/ religious places, etc., to ensure that sustainability of ODF status is continued and that no one is left behind. Such CSCs shall consist of an appropriate number of toilet seats, bathing cubicles, washing platforms, washbasins, etc.

Group of Households to benefit from the CSC should ideally lead and supervise the construction of CSC. Separate facilities for men and women should be ensured in the CSC. The CSC should be made accessible to Divyangjans. Names of all households to benefit from the community toilet may be prominently displayed through a painting on the wall of CSC. Emphasis is to be given to PPP mode for setting up of such projects.



Planning of Community Sanitary Complex

Following general information need to be collected for planning and constructing a CSC in a village.

- Number of households without individual toilet facilities in the village and the probable number of users for a sanitary toilet complex;
- Age profile of the users – the number of children and the elderly;

- Convenient distance from the users' houses– it should not be too far from their houses (otherwise they may prefer open defecation over using community toilets);
- Selection of a suitable site for the sanitary complex is perhaps the most challenging aspect in a village. Such land is usually not available within the targeted community. Sometimes the Gram Panchayat or local landlords may have unused space available to construct the toilet complex. In the case of the latter, the Gram Panchayat and community should approach such landlords to persuade them to provide space for the sanitary complex; and
- Any socio-cultural issues between households in terms of caste and class in the use of common toilets.

Community toilet: A community Sanitary Complex is a facility which is built when there is no required space available for constructing IHHLs. It is used, owned and maintained by community members or local governments. This will be near habitations. It is mostly located within the community, where people reside. A community toilet may also have other utilities such as a bathing facility or a place for washing clothes, depending upon the needs of the community.

Construction of Community Sanitary Complex

Once the Gram Panchayat decides that a community sanitary complex has to be constructed, the work starts on drawing out a detailed plan for the construction and O&M of the complex. The technology options, costs, institutional arrangements, etc., are decided. In doing this, help may be sought from specific field experts such as engineers, finance specialists, institutional experts, etc. All these processes must be undertaken by the GP, in consultation with the community and with support from the experts.



The key processes would include:

- Technology analysis;
- Cost analysis;
- Setting up arrangements for O&M;
- Provision of water for the toilet and bath;
- Construction of facilities, including financial management;
- Finding suitable cost recovery mechanisms, possibly including advertising options.

Community Sanitary Complexes (CSCs) in all villages

(Habitations with predominant landless, migrant, SC/ST population may be prioritized)

Schematic of a 2x2 community toilet

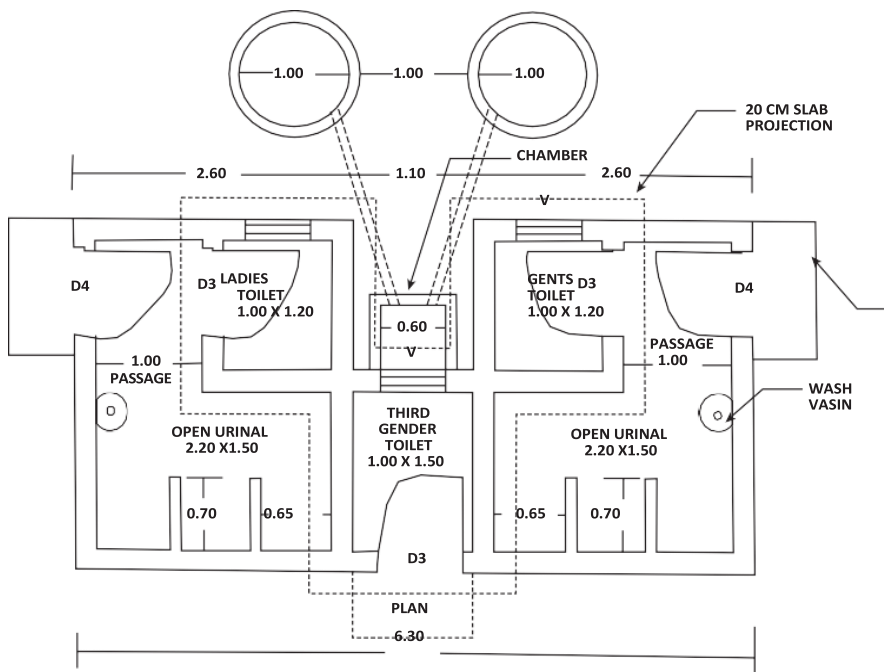
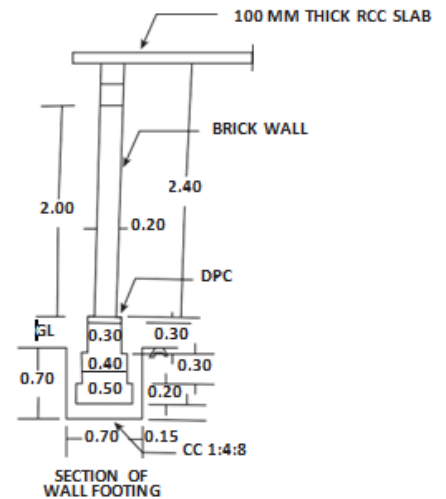
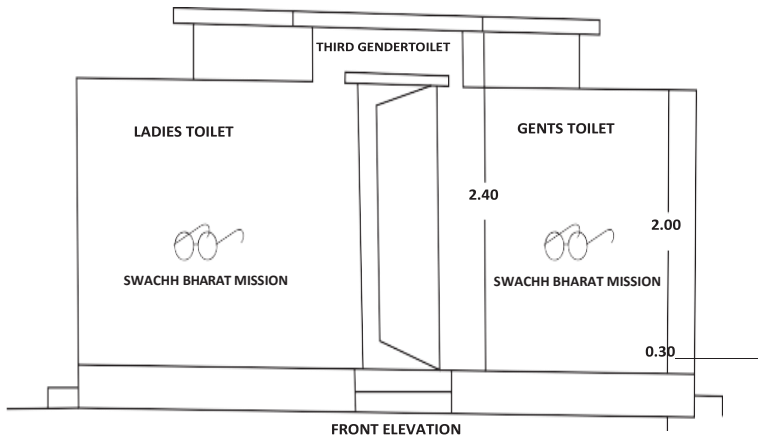

DETAILS OF OPENING: -

D3- 0.80 X 2.00 M PVC FLUSH DOOR
 D4- 0.80 X 2.00 M IRON GRILL DOOR
 V- 0.60 X 0.30 M IRONVENTILATOR

PLINTH AREA:- 19.25
 SQM SLAB AREA:- 10.85 SQM

- **For more details:** Handbook on Accessible Household Sanitation for Persons with Disabilities (PwDs), 2015, Swachh Bharat Mission, Grameen, Ministry of Drinking Water and Sanitation, Government of India, New Delhi
- 'T' for Toilet - A Technical Guidebook for Household Toilets for Different Conditions in Rural Maharashtra, 2014, Water Supply and Sanitation Department, Government of Maharashtra.
- Toilet Technology Options for Swachh Haryana, 2016, Development and Panchayat Department, Government of Haryana.

Technology and management options for Biodegradable Waste Management

Biodegradable waste comprises of a kitchen and institutional waste, animal waste, crop residue, discarded fruits and vegetables and other biodegradable waste such as garden waste in rural areas.

Biodegradable waste is a subset of total solid waste generated in rural areas and is often found mixed with other dry, non-biodegradable waste.

At the household level, biodegradable waste contributed to 60% -80% of the total waste generated. A good proportion of biodegradable waste is used as animal fodder, fuel etc. If not stored in an unscientific manner or just dumped, these may lead to air pollution and contamination of water bodies (particularly during monsoon).

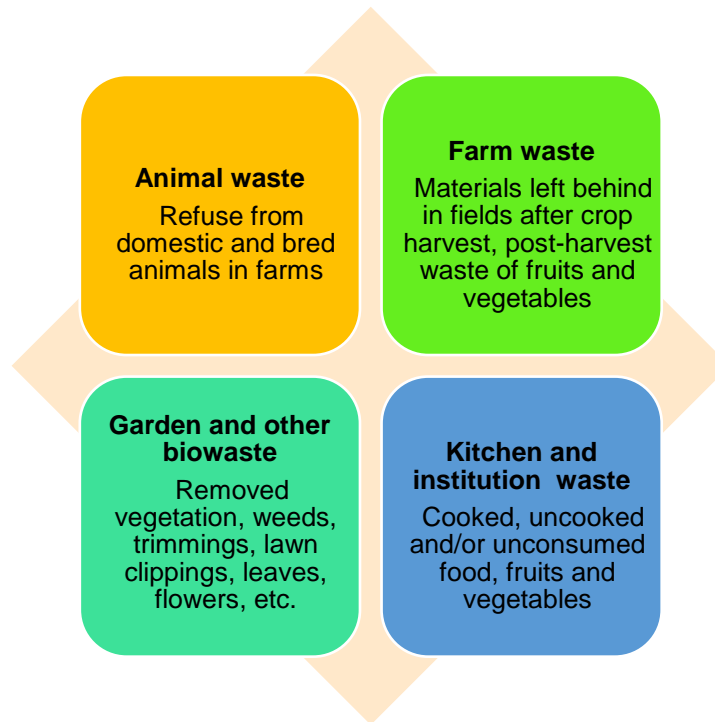

Principles to be followed while designing of bio-degradable waste management systems

Principles that can be followed during the planning and implementation of biodegradable waste management interventions can lead to sustainable outcomes. The needs and preferences of the target population, most appropriate and easy to use technology interventions with low Operation and Maintenance at appropriate levels are some of the principles to be considered.

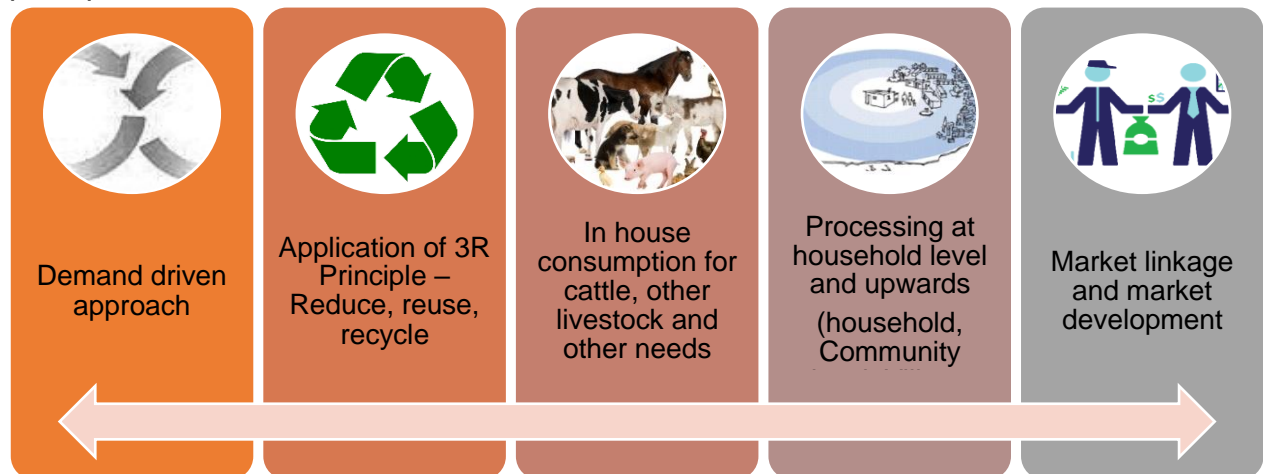

Components of Biodegradable Waste Management

The components of biodegradable waste management include – waste generation, segregation and collection, transportation, treatment and disposal. Though these entire components are often not visible, and provision is not required in majority of the rural areas due to smaller quantities of biodegradable waste (from household chores, excluding agriculture and livestock-related biodegradable waste) and local usage (at generation level itself) and its resource value.

As far as possible, and especially for smaller Gram Panchayats, decentralized household level processing of bio-degradable waste is preferred. Similarly, generation level processing is also preferred for bulk generators like institutions, markets, hotels, temples etc. For large GPs/peri-urban areas, or in areas where household level processing is not feasible, community level and village or even clustering of villages processing may be considered.

Biodegradable waste **collection and transportation** systems are relevant mainly in larger Gram Panchayat (GP) or peri/ semi-urban areas / large densely populated villages, where quantities of waste generated are relatively large. Such Gram Panchayats may be encouraged to set up the door to door collection mechanisms from households and institutions with the use of tricycles, pushcarts or battery-powered vehicles. Household-level segregation of waste may be promoted as well to facilitate efficient community composting.

Almost the entire biodegradable waste generated is expected to be managed during processing to generate useful by-products such as compost, biogas, electricity, etc. Therefore, **disposal** element can be completely nullified as all by-products are utilised.

TECHNOLOGICAL OPTIONS

Composting and bio-methanation are the most appropriate technologies, which can be adopted in a wide range of needs, requirements and scale.

(i) Earthen pot composting (Individual household level)

Pot composting is one of the easiest, safest and most efficient way for composting the biodegradable waste. Pot composting with sufficient aeration does not emit an unbearable smell. Easy availability, simplicity, portability and efficiency make this attractive. It requires very less space and hence suitable for individual household composting.

Specification and Size

- Mud pots about 50cm height and about 35cm diameter at the centre with lid covers – 2 nos. and 3 pots system which is locally moulded with clay/terracotta and oven-dried to be kept vertically one above the other and the pot on the top is covered by a lid.
- Capacity – up to 2kg/day for a family of 5-6 members.



(ii) Pit Composting (individual households and community level)

Compost pits offer a simple and free alternative to purchasing or building a compost bin, as they are made right in the ground within your backyard. This should be the preferred option wherever it is feasible.

Specification and Size

- Household pits: Pits of length of 1m x width 60 cm x depth 1m for a family of 5 or 6 members. Bigger size pits for bigger families according to requirements.
- Community pits: the number and size of the pits are permitted to be altered as per site requirements and land availability keeping the depth as 1m and width as 6-8 feet.



(iii) Pile Composting (Community level)

Aerated static pile composting produces compost relatively quickly and is suitable for a relatively homogenous mix of organic waste.

In aerated static pile composting, organic waste is mixed in a large pile. To aerate the pile, layers of loosely piled bulking agents (e.g., wood chips, shredded newspaper) are added so that air can pass from the bottom to the top of the pile.



(iv) Permanent Tank Composting (Community level)

This method uses a permanently built tank of mud or clay bricks or cement hollow bricks. It is, therefore, important to choose the permanent site for the tank with care. This is good any time of the year where moisture is limited and is the best way to make compost with minimum operation and maintenance cost.



(v) Vermi Composting (Community level)

Composting using earthworms is called vermi composting. Vermi composting process mainly consists of two stages:

- a) Partial degradation/partial digestion of the waste. During this stage, the waste is allowed to decompose to be digestible for earthworms.
- b) Inoculation of the proper number of earthworms.

The process involves decomposition of organic matter by microorganisms already present in the waste. This stage is exothermic and to keep the temperature under control and ensure proper provision of oxygen to keep the mass of waste in the aerobic condition, the waste should be turned once in two days. Earthworm degrades the waste both by physical and chemical break down in their gut. The gut of the worm acts as a bio reactor providing ideal conditions for temperature, pH and oxygen concentration for steady growth of aerobic bacteria which out-compete pathogens resulting in pathogen's destruction. These microorganisms produce useful compounds like antibiotics, vitamins and plant growth hormones.



(vi) Windrow Composting (Community level)

Windrow composting involves forming organic waste into rows of long piles called “windrows” and aerating them periodically by either manually or mechanically turning the piles. The ideal windrow height is between four and eight feet with a width of 14 to 16 feet. This size pile is large enough to generate enough heat and maintain temperatures. It is small enough to allow oxygen flow to the windrow's core.



(vii) Rotary Drum Composting (Community level)

The drum is applicable for rapid composting of kitchen and other organic waste generating from a single household in all seasons without causing any odour, vector, leachate in all seasons. Primary stabilized compost was achieved within 15-20 days. Community scale continuous rotary drum composter of 3.5 m³ capacity is used for high rate composting of 150-200 kg organic waste per day.



The rotary drum can be successfully applied in a small land area for rapid composting of all kind of organic waste (kitchen, cow dung, dry leaves etc.,) generated from household, institutions, and dairies in rural areas.

MATRIX FOR FEASIBILITY OF TECHNOLOGICAL OPTIONS

Technology	Typical waste feed	Scale / level	Topography
Earthen pot composting / Pit Composting	Kitchen waste and small quantity other biodegradable waste	Micro scale, Individual Households	All
Pile Composting	Garden waste, crop residue, kitchen waste	Small to medium scale, households, community level, farm, temples, institutions	All
Permanent tank method	Crop residue, kitchen waste, cattle waste	Small to medium scale, households, community level, farm, temples, market	All
Vermi-composting	Kitchen waste, garden waste, crop residue	Small to medium scale, households, community level, farm, temples, market	All, except too low-temperature areas
Windrow Composting	Crop residue, kitchen waste, cattle waste	Medium to large scale, community level, centralized	All, large GPs, centralized
Rotary Drum Composting	Kitchen waste, garden waste	Small scale, temples, hotels, markets	All areas

COLLECTION VEHICLES AND TRICYCLES



PUSHCART



BATTERY POWERED VEHICLE



Tricycles

For More details:

- *Technological Options for Solid and Liquid Waste Management in Rural Areas, 2015, Swachh Bharat Mission, Grameen, Ministry of Drinking Water and Sanitation, Government of India, New Delhi.*
- *Technical Manual for Scientific Waste Management, Suchitwa Mission, LSGD, Kerala*

Guidelines and technology options for GOBAR-DHAN [GALVANIZING ORGANIC BIO-AGRO RESOURCES DHAN]

Background

Rural India generates enormous quantities of bio-waste including animal waste, kitchen leftovers, crop residue, market waste and fecal sludge. According to the 19th Livestock Census of India, 2012, there are about 300 million bovines, 65.07 million sheep, 135.2 million goats and about 10.3 million pigs. At least 5,257 tonnes of waste/day is estimated to be generated from livestock alone. Also, according to Indian Agricultural Research Institute's estimates in 2014, India generated 620 million tonnes of crop residue, of which 300 million tonnes are treated as waste and 100 million tonnes are burnt on farms.

To ensure cleanliness in villages and generate wealth and energy by converting cattle dung and solid agricultural waste into compost and biogas and to improve the lives of villagers, the launch of 'Galvanizing Organic Bio-Agro Resources Dhan' (GOBAR-DHAN) project was announced in the Budget Speech of the Hon'ble Finance Minister in Feb 2018. This initiative is to support biodegradable waste recovery and conversion of waste into resources. The GOBAR-DHAN scheme is expected to engage with people in safe and efficient managing of solid waste, especially the bio-agro waste in villages so that the villages remain clean.

Planning and Implementation

Under the programme, individual and community level, biogas plants can be constructed at villages/ Blocks/District. But at least one model community-level biogas plant per district is mandatory under the programme. The States and Districts can plan more projects on GOBAR-DHAN in convergence with other schemes like NNBOMP of Ministry of New and Renewable Energy.

For model GOBAR-Dhan projects, the districts should preferably take up community-level projects near Gaushalas for uninterrupted supply of organic wastes to make the projects sustainable in the long run as well as to promote business models. However, the district will have the flexibility to take up household level projects wherever feasible.

The biodegradable waste generated in peri-urban villages and other villages, near to CBG (Compressed Bio-Gas) plants set up under SATAT Scheme of Ministry of Petroleum and Natural Gas, can be utilized in such CBG plants.

Additionally, more GOBAR-Dhan projects may be set up by Block at individual/community levels in the villages that cannot be covered under SATAT Scheme, with the 15th Finance Commission grants to RLBs or other resources of GP/Distt/State, as per the financial assistance norms under NNBOMP of MNRE.

Appropriate business models to be used for setting up of more projects at village/GP/Block/district level. The State/District may also emulate the model projects for

setting up more GOBAR-Dhan projects at village/Gram Panchayat/Block/district level, wherever needed and feasible/viable, from their sources or other funds or convergence with other schemes of State or Central Governments.

District Plan

Every district must include at least **one model** project in the District Implementation plan, which will form part of PIP/AIP of the State. The District can plan community biogas plants near Gaushalas/ vegetable markets/institution/religious sites/factories (sugar processing) /fish markets/piggeries/slaughterhouses/food complexes, etc. where bio-degradable waste is generated in large quantities.

Individual biogas plants are also allowed for households having cattle and in hilly areas where collection and transportation of biodegradable waste is difficult. The District plan should contain details on the utilisation of biogas and bio slurry.

IMPLEMENTATION ROLES

Role of Gram Panchayat

The GP should plan individual biogas plants for each of its villages by listing the households where cattle are more than 5 and dumping the cattle dung on roadsides. The funding for such projects will be in accordance with the NNBOMP scheme of MNRE. Biogas plants of 1-3 m³ can be planned for such individual plants.

If common space is available in a village, and a village has more cattle population, then in such villages community biogas plants of capacity 4-10m³ can be planned. Funding norms will be in accordance with the NNBOMP scheme of MNRE.

The Gram Panchayat where the project is implemented should be involved in disseminating IEC and awareness on waste segregation, biogas and bio-slurry benefits and provide support in managing bio-slurry. GP should also ensure that bio-slurry from plants is not disposed in drains or create disposal issues.

Role of District

The intended end objective of this project is to manage biodegradable solid waste generated in villages considerably. Hence the District must plan, implement and monitor the project. DWSC shall be the nodal agency for project approval and monitoring at the district.

The project preparation, supervision and monitoring costs of the projects to be made a part of the project cost itself. Maintenance costs for the first five years of operation may be made a part of the project cost.

The district can decide on agencies for implementation of the project. They should select agencies with a reliable proven record on implementing such projects. Agencies having a minimum of 3 years' experience on implanting Biogas plants may be chosen based on track record and proven sustainable models. The District can also decide on getting support from any technical agency.

Districts may choose to take support from BDTCs/ State Nodal Agencies (SNAs) for Renewable energy such as PEDDA/UPNEDA/GEDA/NEDCAP/ KREDL/ANERT/TEDA/ CREDA/ MPUVN/ WBREDA/ OREDA/UREDA/ KVIC/ etc. State may empanel technical

agencies, biogas/bio-energy consultants, on their State website to be readily engaged by districts and entities. Reputed biogas equipment manufacturers may also be empanelled, to facilitate local manufacturing, supply and installation of biogas equipment.

Any additional cost requirement is to be met by funds from the State/GP and other sources like Finance Commission, CSR, Swachh Bharat Kosh and PPP model. Dovetailing funds from other programmes and sources of funding like MGNREGS, MPLAD, MLALAD funds, Finance Commission, CSR contribution, Swachh Bharat Kosh, donor funding, etc. may be done. An entity can also avail financial assistance through MUDRA, NABARD etc. if required.

Monitoring

DWSC is the monitoring agency at the district level, where all the plants set up under GOBAR-DHAN scheme shall be physically verified during each quarter and the status of functionality shall be uploaded on the national IMIS. The projects shall be audited every year. State shall also set up an independent evaluation mechanism to monitor the functioning of plants installed and successful operation of the project vis a vis the objective of the scheme. This may be a bi-annual exercise, at least for the first two years of the scheme. State may also set up a mechanism to receive grievances from villages and ensure redressal of the same promptly.

TECHNOLOGICAL OPTIONS

The District / State can decide on the technology to be adopted in the construction of biogas plants in their State or District based on the quantity of waste generated. Biogas plants need to be constructed in areas where an uninterrupted supply of waste is ensured. Biogas, a product of anaerobic digestion (the fermentation in the absence of air) of organic wastes/materials like cattle dung, poultry droppings, pig excreta, human excreta, crops/crop residues, kitchen waste etc., is a very suitable fuel for providing cooking fuel, lighting, running dual fuel / 100% biogas based engines for operating irrigation pumps/electricity generation etc. Anaerobic digestion not only provides valuable fuel and enhances the fertilizer value of the waste, but also provide a convenient, safe, aesthetical and economical waste disposal method.

Biogas Equivalents

By the use of 1 m³ of biogas, the undermentioned sources of energy can be saved:

1 m³ of biogas = 3.50 kg of wood / 12.30 kg of cattle dung cakes / 0.43 kg of LPG / 0.62 litre of kerosene oil / 1.6 kg of coal / 1.46 kg of charcoal / 0.52 litre of diesel / 1.25 kW of electricity

Selection of Proper Size of Biogas Plants

- The size (capacity) of biogas plant means the quantity of biogas (in cubic metres) which we can get from it in 24 hours.
- It is considered that an average of 15 kg of cattle dung is collected from an animal and from one kg of cattle dung about 0.04 m³ of biogas is collected.
- Thus, from 25 kg of cattle dung, about 1.0 m³ of biogas is collected.
- Based on the above details, the requirement of the quantity of dung and number of animals for different size of biogas plants is shown as below :

Capacity of biogas plant (m ₃)	No. of animals required	Quantity of dung required (kg)	Cooking for number of persons
1	2-3	25	2-3
2	3-4	50	4-5
3	5-6	75	7-8
4	7-8	100	10-11
6	10-12	150	14-16

Selection of Site for Installation of Biogas Plant

- The site for biogas plant should be at a higher level as compared to the surroundings so that there should not be the accumulation of water near the biogas plant.
- Biogas plant should be installed at least 2 metres away from the foundation of the house to avoid cracks in the building.
- Biogas plant should be installed near the kitchen and animal shed to save the cost of delivery gas pipe and carriage of dung.
- Biogas plant should be installed in the open space. There should not be any tree near the plant, to have the full benefit of sunlight and also the roots of the tree should not damage the biogas plant.
- Biogas plant should be installed underground to avoid the cracks in the dome (gas holder).

SOME POPULAR BIOGAS PLANT DESIGN OPTIONS

Household-level options

I. Floating-Drum Type / KVIC Model Biogas Plant

These plants have an underground well-shaped digester having inlet and outlet connections through pipes located at its bottom on either side of a partition wall. An inverted drum (gas holder) made of mild steel is placed on the digester which rests on the wedge-shaped support and the guide frame at the level of the partition wall and moves up and down along a guide pipe with the accumulation and use of gas. The weight of the drum applies pressure on the gas to make it flow through the pipelines to the points of use.

This model has a relatively shorter working life. The drum needs to be painted regularly for protecting it against corrosion damage. Also, when the temperature falls to below 10 degrees Celsius, this model ceases to function as the iron sheet gas holder acts as a good conductor of heat and an inner temperature of the digester falls. These plants can be of any size to cater to the needs of the users.

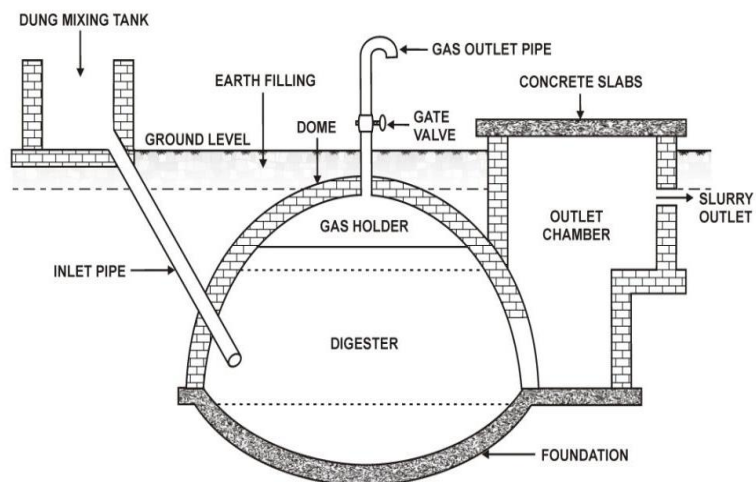

II. Deenbandhu Model Biogas Plant

The world Deenbandhu means ‘friend of the poor’. This plant is designed on the principle that the surface area of biogas plants is reduced (minimized) to reduce their installation cost without sacrificing the efficiency of the plant.

The design consists of segments of two spheres of different diameters, joined at their bases. The structure thus formed, acts as the digester, as a fermentation chamber, as well as the gas storage chamber. The higher compressive strength of the brick masonry and concrete makes it preferable to go in for a structure which could always be kept under compression.

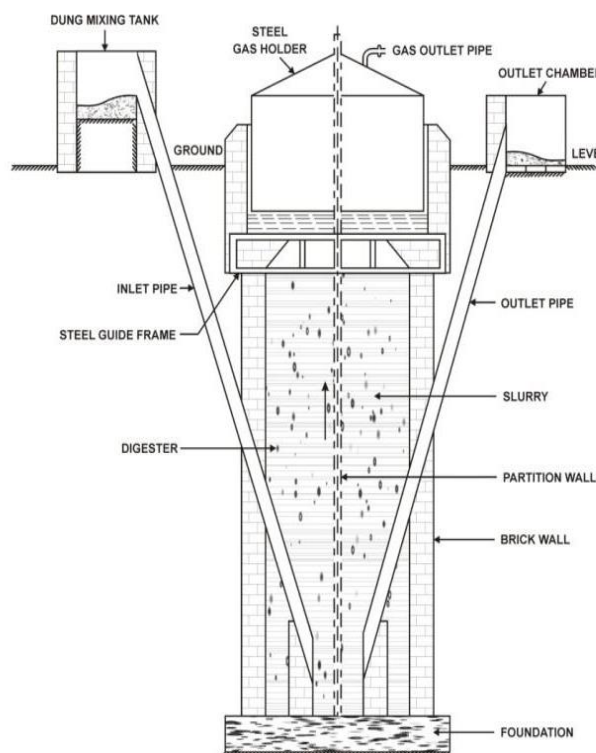

Aspherical structure loaded from the convex side will be under compression and therefore, the internal load will not have any residual effect on the structure. The digester is connected with the inlet pipe and the outlet tank. The upper part above the normal slurry level of the outlet tank is designed to accommodate the slurry to be displaced out of the digester with the generation and accumulation of biogas and is called the outlet displacement chamber.

The size of these plants is recommended up to 6 m³ per day.

Large capacity plants for Dairy Farm / Gaushala / Poultry Farms / Institutes / Villages

III. Fixed Dome PAU Janta model biogas

The construction of this type of plant is not very different from the method for the Deenbandhu Biogas Plant. The Ministry of New and Renewable Energy (MNRE), Govt. of India has accepted this design for the extensive adoption by end-users to produce biogas and cogeneration.

The biogas plant is an all brick masonry structure. The design is suitable for all regions of the country. The plant may be designed for any rated capacity from 20 to 500 m³/day. Maintenance requirements of bricks masonry plants are far lesser than the floating drum biogas plants. The cost of this plant is 60 – 70% as compared to the cost of the KVIC model biogas plant. The payback period of this plant is between 3 to 4 years. This plant has been designed for catering the needs of dairy farmers, poultry farmers, institutes like gaushalas, educational institutions, religious institutions, villages, industries etc.

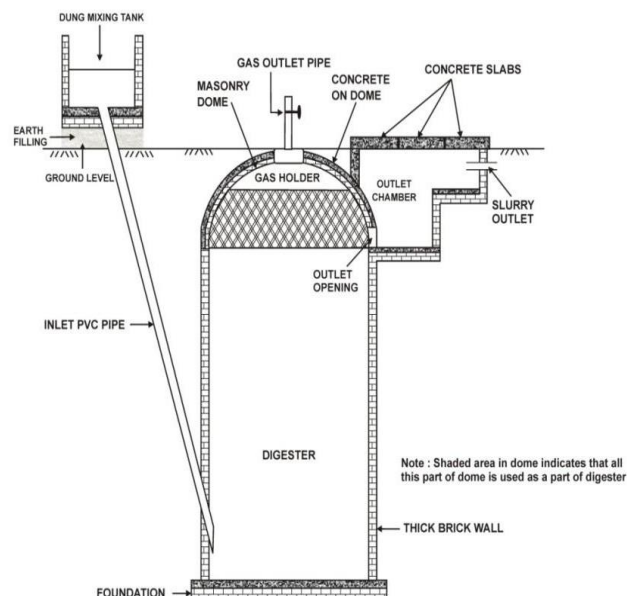

Comparative cost for installation of different type of individual daily fed biogas plants (All values in Rupees in December 2017)

S.N.	Model	Plant Capacity			
		2 m ³ (70 ft ³)	3 m ³ (105 ft ³)	4 m ³ (140 ft ³)	6 m ³ (210 ft ³)
1.	PAU Janta	23,000	26,000	29,000	35,000
2.	Deenbandhu	32,000	37,000	43,000	50,000
3.	K.V.I.C	50,000	55,000	60,000	70,000

Apart from the above options, there are other models made from different materials like FRP, PVC reinforced concrete etc., of both the fixed and floating variety which may also be used. Some of these models are available as pre-fabricated structures as well.

For more details :

- *Renewable Energy Biogas an Ideal Source, 2016, Punjab Agricultural University*
- *Large capacity fixed dome solid-state biogas plant, 2017, Co-ordination cell ICAR, AICRP on EAAI, Bhopal (M.P.)*

Plastic Waste Management options in Rural Areas

About 15,000 tonnes of plastic waste is generated across India, of which, 60% is recycled and 40% (~6000 tonnes) is disposed. Plastic waste disposal methods in many parts of rural India are often basic and uninformed. The open burning of plastics generates toxic emissions such as carbon monoxide, dioxins, furan etc. The Plastic Waste Rules (2016) were extended to rural areas for the first time, with specific duties demarcated for Gram Panchayat. This document captures processes and technologies to safely collect and dispose the plastic waste in rural areas.

Plastics Waste Management System and Its Elements

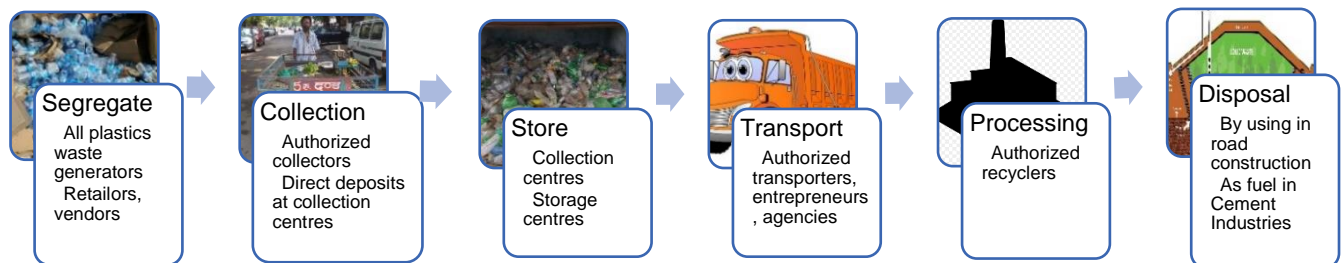

Elements of the Plastic Waste Management Plan

Village level:

- Door to Door Collection from households, commercial areas, restaurants, markets etc.
- Transportation to the Village level shed, where segregation takes place (household segregation can be promoted by the village for higher efficiency)
- Plastics that have value can be sold to recyclers
- Segregated plastic from village sheds can be sent to Material Recovery Facility or Plastic Waste Management Unit
- Awareness creation and monitoring, empanelling agencies, vendors and recyclers can be coordinated by GP

Block / District level:

- Set up Material Recovery Facility / Plastic waste management Units at Block / District
- Plastic waste management with Shredder/ Bailing Machine/ Dust remover etc.
- Shredded plastic can be forwarded for further use
- Market linkages and MoU with Cement industries for use as fuel

MANAGEMENT OPTIONS

Door to Door and Street Collection of Non-biodegradables including Plastics

Sheds at Village for Segregation and transfer (Material Collection Facility)

Plastic Waste Management at Block/District level - Shredding/Bailing

Send for Road Construction/ Co-Processing in Cement Industries/ recycling, from Blocks or from Districts

Door-to-Door Collection and Transportation



DETAILS OF VILLAGE SHEDS (MATERIAL COLLECTION FACILITY) AND PLASTIC WASTE MANAGEMENT UNIT/ MATERIAL RECOVERY FACILITY AT BLOCKS/DISTRICTS LEVEL

A common shed for bio degradable and non-biodegradable waste in a village : All village must have a collection and segregation sheds for plastic waste management. The non-biodegradable (plastic) waste reaching these sheds can be segregated and transported to the material recovery facility or plastic waste management units at Block/District. The materials that have value can be sold to scrap dealers and village/GP can earn income.

Village Sheds for Segregation

The village shed can be simple and can be made with locally available materials. The shed can have a roof and space for segregation. No machinery is needed in the village shed other than simple tools and basic safety gear.

Valuable materials like bottles, broken plastic buckets etc. that can be recycled should be segregated and the village can earn income by selling it through scrap dealers, or the same can be done at the Block where the scrap dealers will get a maximum quantity of recyclable materials. The district must ensure enlisting of scrap dealers at all appropriate levels they deem necessary.





Plastic Waste Management Units(Block/ District level)

A materials recovery facility, materials reclamation facility, materials recycling facility or Multi re-use facility is a specialized plant that receives, segregates and recyclable materials which may be marketed to end-user manufacturers. There must be at least one MRF in each Block if no clustering is possible, which may be provided with a shredding machine, a baling machine and a dust remover, among other necessary items.

(i) Plastic Shredding Machine:

A plastic shredder is a machine used for cutting the plastic in small pieces to make waste management easier. Shredding and size reduction is most commonly utilized in the plastic recycling process. This shredded plastic can then be sent onward to be used in road construction.



(ii) Plastic Baling Machine (hydraulic)

Balers are typically used to compact similar types of waste, such as office paper, corrugated fiberboard, plastic, foil, cans etc. for sale to recycling companies. These balers are made of steel with a hydraulic ram to compress the material loaded. The collected plastic need to be bailed for further transportation and use.



(iii) Dust Remover Machine

A lot of plastic dust is generated during the process of shredding and baling. Hence for health and environmental aspects, this machine may be part of the plastic waste management unit.



DISPOSAL METHODS

(i) Road Construction

From rural roads to National Highways, shredded plastic waste can be used in the construction of all types of roads. The district must identify potential road construction sites and facilitate the transfer of the shredded plastic for road construction. The district must also satisfy itself that the construction operations follow all the necessary environmental and safety protocols.

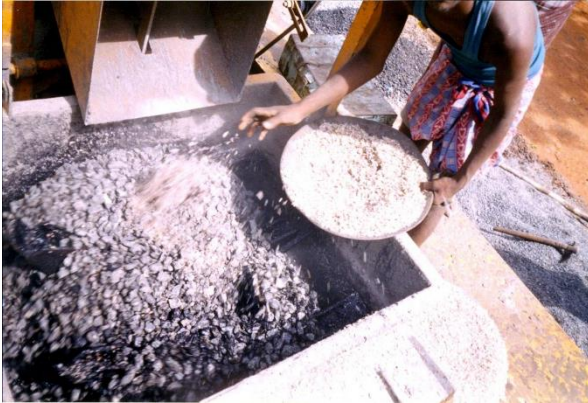

(ii) Co-Processing in Cement Industries

Co-processing refers to the use of waste materials in industrial processes as alternative fuels or raw material (AFR) to recover energy and material from them. Due to the high temperature in cement kiln, different types of wastes can be effectively disposed without harmful emissions. Disposal of different categories of plastic wastes through co-processing is practised in many countries as a regular method for their environmentally sound disposal. Co-processing is a more environmentally friendly and sustainable method of waste disposal as compared to land filling and incineration because of reduced emissions and no residue after the treatment.

List of Cement Plants Having Co-processing Facility (CPCB Guidelines, 2017)

S. No.	Cement Plant	S. No.	Cement Plant
1.	M/s Ambuja Cements Ltd., Bhatapara, PO – Rawan, Tehsil Baloda Bazar, Distt. Raipur, Chhattisgarh	2.	M/s Shree Cement Ltd., AndheriDeori, Post Box No. 33, Bangur Nagar, Beawar, District – Ajmer, Rajasthan – 305901
3.	M/s ACC Ltd., Lakheri Cement Works, P.O. Lakheri, Distt. Bundi (Rajasthan), 323 603	4.	M/s ACC Ltd., Kymore Cement Works, P.O. Kymore, Distt. Katni (MP), 483 880
5.	M/s ACC Ltd., Madukkarai Cement Works, P.O. Madukkarai, Distt. Coimbatore Tamil Nadu-641 105	6.	M/s Vasavadatta Cement, Post andTq- Sedam, Distt. Gulbarga Karnataka, 585 222
7.	M/s ACC Ltd., Gagaj Cement Works, P.O. Barmana, Distt. Bilaspur (HP), 174 013	8.	M/s ACC Ltd., Bargarh Cement Ltd., Cement Nagar, PO Bardol, Distt. Bargarh (Orissa), 768 038
9.	M/s Lafarge India (P). Ltd., Arasmeta Cement plant, PO Gopal Nagar, Janjgir, Champa, Chhattisgarh	10.	M/s Ambuja Cements Ltd., Suli, P.O. Darlaghat, Distt. Solan (HP)
11.	M/s Lafarge India Ltd., Sonadih Cement Plant, PO Reseda, Via Baloda Bazar, Distt. Raipur (Chhattisgarh)	12.	M/s ACC Ltd., Jamul Cement Works, Distt. Durg Chhattisgarh 490 024
13.	M/s Ambuja Cement Ltd., P.O. Ambujanagar, Tal.-Kodinar, Distt. Junagadh, Gujarat –362715	14.	M/s GajAmbuja Cements Ltd., Tal.-Kodinar, Distt. Junagadh, Gujarat – 362715
15.	M/s Ambuja Cements Ltd., P.O. Rabriyawas, Teh. Jaitaran, Distt. Pali Rajasthan	16.	M/s Trinetra Cement Ltd., Mahi Cement Works, P.O. Walwana, Banswara – 327 025, Rajasthan
17.	M/s ACC Ltd., Chanda Cement Works, P.O. Cement Nagar, Distt. Chandrapur, Maharashtra 442 502	18.	M/s Shree Cement Ltd., Village-RAS, Tehsil-Jaitaran, Distt.-Pali, Rajasthan.
19.	M/s ACC Ltd., Chaibasa Cement Works, P.O. Jhinkpani, Distt. West Singhbhum, Jharkhand 833 215	20.	M/s ACC Ltd., Wadi Cement Works, P.O. Wadi, Distt. Gulbarga Karnataka 585 225
21.	M/s Bharathi Cement Corporation Pvt. Ltd. Nallalingayapalli village, KamalapuramMandal, KadapaDistt. – 516 289, Andhra Pradesh	22.	M/s My Home Industries Limited Mellacheruvu (Post and Mandal) NalgondaDist - 508246 Telangana State
23.	M/s Anjani Portland Cement Ltd, MellacheruvuMandal, NalgondaDistt., Telangana State 508246	24.	M/s Kesoram Cement Ltd., Post-Basantnagar, Karimnagar Dist.- 505 187 (AP)
25.	M/s Sagar Cement Ltd., Nalgonda, Telangana	26.	M/s Lafarge India Pvt. Ltd. Chittor Cement Plant Chittorgarh, Rajasthan
27.	M/s Kalburgi Cement (formerly VicatSagar Cement), Chhatrasala, Gulbarga, Karnataka	28.	M/s Dalmia Bharat Cement, Ariyalur, Tamilnadu

29.	M/s J.K.Cement Works, Muddapur, Bagalkot, Karnataka	30.	M/s Sanghi Cement Ltd., Kutch, Gujarat
31.	M/s Chettinad Cement Corporation Ltd., Kallur Works, Sangem K, Garagappalli Post, Chandapur (SO), Chincholi (TK), Gulbarga (DT), Karnataka-585 305	32.	M/s Chettinad Cement Corporation Ltd., AriyalurTrichy Road, Keelapur post, Ariyalur dist-621707, Tamilnadu
33.	M/s Dalmia Cement (Bharat) Ltd., Dalmiapuram, Dist.Tiruchirapalli, Tamil Nadu621651	34.	M/s J. K. Cement Works, Mangrol, C/o J.K. Cement Works, Kailash Nagar, Nimbahera, Distt. Chittorgarh 312617
35.	M/s J. K. Cement Works, Kailash Nagar, Nimbahera, Distt. Chittorgarh 312617	36.	M/s Zuari Cement Ltd., Krishna Nagar, Yerraguntla, Kadapa Distt., AP 516 311
37.	M/s Zuari Cement Ltd., Sitapuram, Dondapadu, Distt.- Nalgonda, Telangana	38.	M/s Dalla Cement Factory, Village – Dalla, Distt. – Sonebhadra, UP 231207
39.	M/s Dalmia Cement (Bharat) Ltd., VandP- Chinnakomerla, Mandal-Mylavaram, Jammalandhu, Distt. Kadapa, AP	40.	M/s Chettinad Cement Corporation Ltd., Rani Meyyammai Nagar, Karikkalai PO, Guziliamparai (via), DindigulDistt., Tamilnadu 624 703
41.	M/s J. K. Lakshmi Cement Ltd., Jaykaypuram, Distt. Sirohi, Rajasthan 307 01	42.	M/s Keerthi Industries Ltd., Mellacheruvu (V and M), NalgondaDistt., Telangana 508 246
43.	M/s India Cements Ltd., Malkapur Village, TandurMandal, Ranga Reddy Distt., Telangana 501 157	44.	M/s Chettinad Cement Corporation Ltd., Puliur CementWorks, KarurDistt., Tamilnadu
45.	Ultra Tech Cement Ltd., Andhra Pradesh Cement Works, Bhogasamudram, PO: Chukkalur, Mandal:Tadipatri Distt. Anantapur (AP)	46.	M/s UltraTech Cement Ltd., RajashreeCemeworks, AdityanagarMalkhed Road, Dist. Gulbarga, Karnataka 585 292
47.	M/s Ultratech Cement Ltd., Narmada cement-Jafrabad Works, Babarkot, Taluka- Jafrabad, Distt. Amreli, Gujarat.	48.	M/s Ultra Tech Cement Ltd. P.O. Mohanpura, Tehsil Kotputli, Distt. Jaipur, Rajasthan- 303108
49.	Ultra Tech Cement Ltd., Aditya Cement, Adityapuram, P.O. Sawa Distt. Chittorgarh, Rajasthan -312 612	50.	Ultra Tech Cement Ltd. P.O. Reddipalayam, Ariyalur, Distt. Perambalur, Tamil Nadu-621 704
51	Ultra Tech Cement Ltd. Gujarat Cement Works, P.O. Kovaya, TalukaRajula, Distt. Amreli Gujarat-365 541	52.	UltratechCemenLtd., Vikr Cement Works, Vikram Nagar, P.O. Khor, Distt. –Neemuch, M.P. – 458 470.
53.	M/s Ultra Tech Cement Ltd., Rawan Cement Works P.O. Grasim Vihar, Distt. Baloda Bazar – Bhatapara, Chhattisgarh – 493196	54.	M/s Ultra Tech Cement Ltd., Hirmi Cement Works, Hirmi, Bhatapara, Distt. Baloda Bazar Chhattisgarh – 493195

Technology and management options for Greywater Management

Water 'wasted' as a result of various human activities at home, in businesses, or industries is called liquid waste or waste water. In rural areas, waste water is broadly classified as domestic waste water (black water and Greywater) and commercial waste water (black water and Greywater) emanating from small scale industries, hotels, slaughter houses, laundries etc.

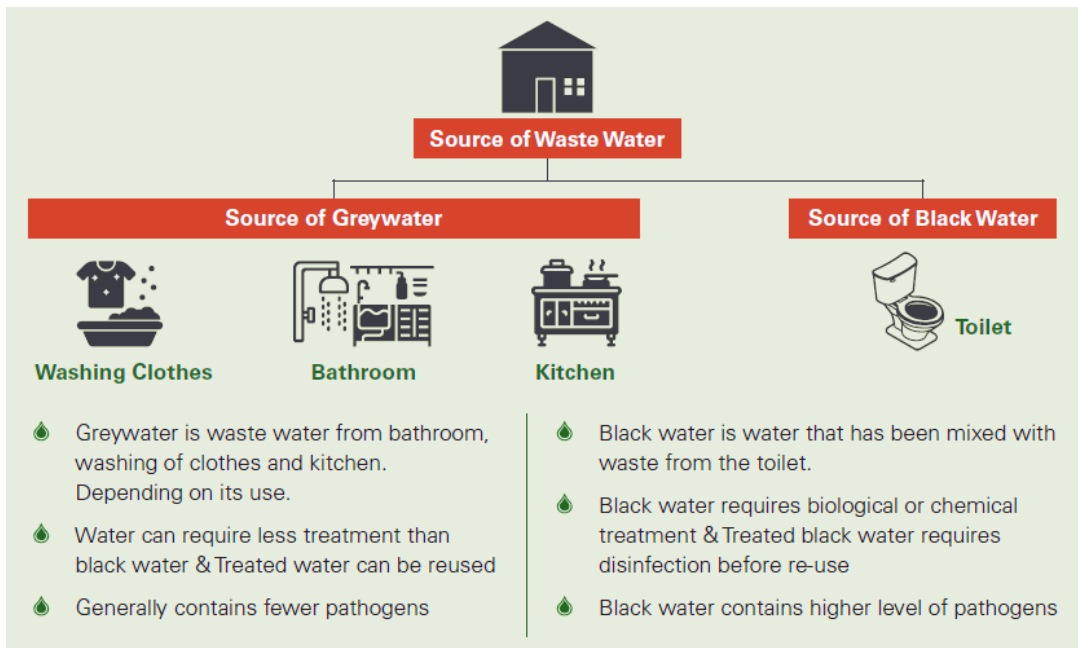

Greywater

Wastewater from bathrooms or kitchens that has no fecal contamination is called Greywater. Examples of Greywater include wastewater from the bath, shower, laundry, and kitchen sink. It is estimated that 15,000 to 18,000 million litres of Greywater are generated each day in rural areas of India.

Greywater is generated due to household activities; its main characteristics strongly depend on factors such as cultural habits, living standard, household demography, and types of household chemicals used. Greywater is the least contaminated type of wastewater which needs very less degree of treatment.

Basic Principles of Greywater Management

Below are some of the principles to be considered during the planning of greywater management systems in a village. These must be considered in conjunction with the needs and preferences of the target population. The most appropriate and easy to use technology interventions with low operation and maintenance must be chosen at appropriate levels and conforming to these broad principles.

- **Reduce:** Judicious use of fresh water which will result in the generation of a minimum quantity of Greywater
- **Reuse:** Reuse of Greywater for purposes such as kitchen garden, vehicle washing, toilet flushing etc to the maximum possible extent.
- **Recharge:** Recharge of ground water with Greywater by adopting technologies such as soakage pit, leach pit etc
- ✓ Separation of Black Water (if any) and Greywater
- ✓ Treatment of Greywater at the nearest possible point from the point of generation.

In smaller GPs / villages, more decentralised and household centric approaches like individual soak pits/ leach pits/magic pits/kitchen garden are more feasible and preferred. For larger villages but with a population of less than 5000, community level soak pits may be planned based on the terrain, groundwater level and density of population.

Villages with more than 5000 population should plan for a conveyance system like underground / small bore sewers / closed drainages and treatment systems like WSP / DEWATS / constructed wetlands and other treatment systems. However, States will have the flexibility to take up a conveyance and treatment systems for smaller villages as well depending on the agro-climatic factors, with additional funds supported from the 15th Finance Commission and convergence from other State funds.

Technology Selection Criteria

Even within a village, there can be multiple options for individual households or a group of houses. While planning for a GP, the following algorithms can help select the technology depending upon the geo-hydrological condition of the GP.



(B) For Areas with seasonal or permanent high-water table / Water logged areas



(C) For Areas with hard strata (rocky strata)

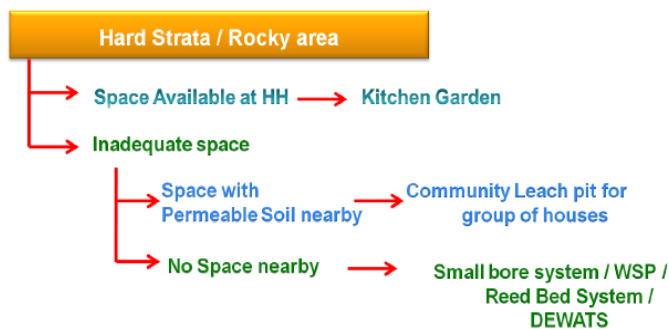

TECHNOLOGICAL OPTIONS

Household level intervention

- **Soak Pit** - Dug out pit filled with stones or preferably over burnt bricks. The large numbers of stones increase the surface area over which biological and chemical action takes place.
- **Leach Pit** – Leach Pit is a brick-lined pit constructed in honeycomb masonry having a volume of about 0.75 cubic meters.
- **Magic Pit** - A Magic pit is a covered, porous-walled chamber that allows water to slowly soak into the ground. Pre-settled effluent from a collection tank is discharged to the underground chamber.

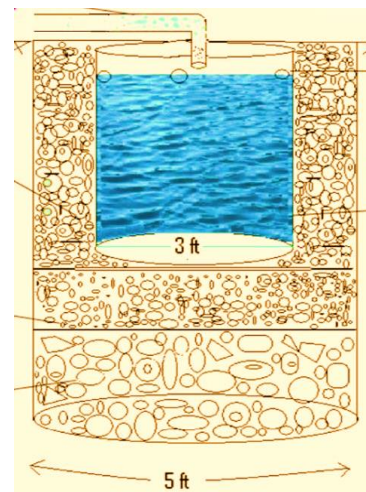
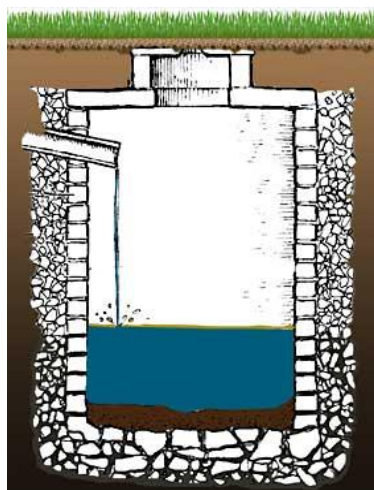
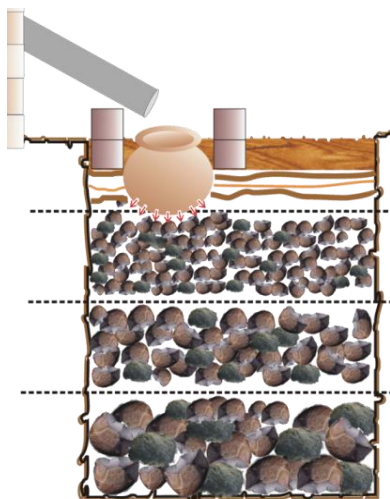

Community level Interventions

For community level interventions on waste water management, the conveyance of waste water from the source of generation to a point of treatment is needed. For that, usually conventional drains (open/closed) or small bore sewers can be used.

(i) Community Leach pit

This is a brick-lined pit constructed at a convenient place for a group of houses. The number of houses to be connected should be calculated based on the Greywater discharged from each house and the space available for the community leach pit. Greywater from the houses (kitchen waste water, bathing water, washing water, etc.) should be carried to this pit.

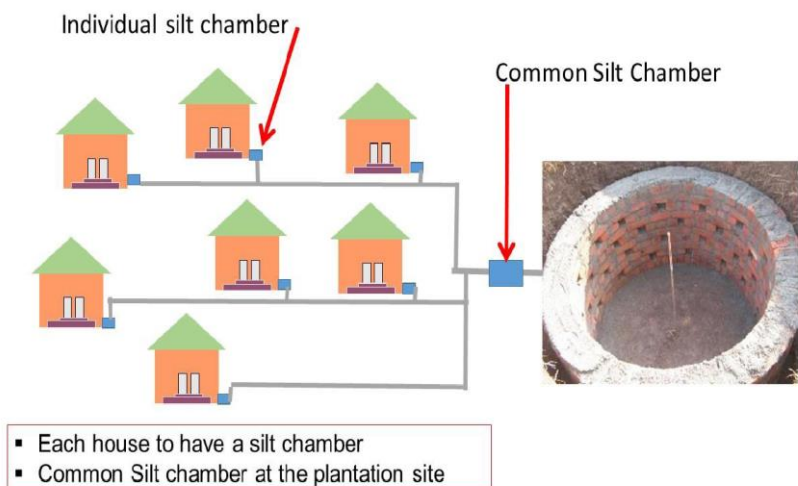

(ii) Waste Stabilization Ponds

Waste stabilization ponds (WSP) are shallow man-made basin into which wastewater flows and from which, after a retention time of a few days a well-treated effluent is discharged. WSP systems comprise of a series of ponds- anaerobic, facultative and maturation ponds in series.

Essential Components of the System

The system has three basic units called ponds, placed in series and characterized by their function such as:

1. Anaerobic pond – one number
2. Facultative pond – one number
3. Aerobic pond or maturation pond – one or more in number depending upon the impurities in the Greywater



(iii) Constructed Wetland (CW)

A horizontal flow constructed wetland (horizontal flow CW) is a planted filter bed for treatment of wastewater (e.g. Greywater or black water). Horizontal subsurface flow

constructed wetland is large gravel and sand-filled channel that is planted with aquatic vegetation. As wastewater flows horizontally through the channel, the filter material filters out particles and microorganisms degrade organics. The waste water is treated by a combination of biological and physical processes. The effluent of a well-functioning constructed wetland can be used for irrigation and aquaculture or safely discharged to receiving water bodies. Horizontal flow CW is relatively inexpensive to build where land is affordable and can be maintained by the local community as no high-tech spare parts, electrical energy or chemicals are required.



(iv) Decentralized Wastewater Treatment System (DEWATS™)

DEWATS is a proven nature-based treatment technology suitable for wastewater treatment including greywater which works under gravity negating the requirement of any electro-mechanical components and hence provides the advantage of minimal maintenance. The DEWATS module for each project/situation can be customized based on different quantity and quality of incoming wastewater characteristics. The DEWATS is chemical-free and cleans the water through natural processes, preserving resources and demonstrating the value of reusing and recycling water especially in water scarce areas.



DEWATS follows four stages of treatment which could be designed based on the characteristics of inflow water and the level of treatment required.

(v) Phytorid technology

Phytorid is a scientifically developed systematic treatment methodology for waste water. Phytorid combines Physical, Biological and Chemical processes. It works on gravity, cost-effective technology with no electric power requirement, scalable technology, easy to maintain and adds to aesthetics.



A primary treatment facility would also be constructed along with basic for effective removal of solids and thus reduces the marginal BOD. The porous media also supports the root structure of emergent vegetation. The design of the Phytorid system assumes that the water level in the cells will remain below the top of the filter media. The vegetation to be utilized for the said Phytorid system is very important. Various species of aquatic plants have been utilized to attain maximum

efficiency in the treatment of domestic wastes. These include species like Phramites australis, Phalaris arundinacea, Glyceria maxima, Typha spp., other common grasses etc. This technology is a natural system; as a result, the operation is mostly passive and requires little operator intervention.

CONVEYANCE SYSTEMS

One of the cheapest and interim options for disposal of Greywater, Greywater + septic tank effluent is the covered surface drains. Further, open channels often exist in rural areas and hence can be upgraded to covered drains with little efforts.



The objective of covered surface/storm water drain is to remove waste water/ rain water from the households/ premises in a controlled and hygienic manner to minimize public health and environmental risks. Open drain/channel have higher friction than a pipe. In relatively flat areas, pipe flow could be better, an alternative option would be laying the pipe into the open channel and cover it.

Small Bore Sewers

Small bore sewer systems are designed to receive only the liquid portion of household wastewater for off-site treatment and disposal. Grit, grease and floating materials are separated from the waste flow in interceptor tanks like septic tanks. Such interceptor tanks are installed after each household or group of households as per the site conditions. Depending upon the size of interceptor tanks and inflow of waste water, settled solids should be removed periodically from the interceptor tanks. Sewers are small bore pipe (minimum diameter of 100 mm) which is



trenched into the ground at a depth enough to collect the settled wastewater from most connections by gravity. Unlike conventional sewers, small bore sewers are not necessarily laid on a uniform gradient with straight alignment between manholes or cleanouts. (For details: Technological Options for Solid and Liquid Waste Management in Rural Areas, DDWS, 2015)

These conveyance systems should end into treatment systems like Community leach pits, Waste Stabilisation Ponds, Constructed wetlands, DEWATS, Phytoid technology etc.

(For more details, please refer to Greywater management in Rural India, DDWS 2018)

Faecal Sludge Management options in Rural Areas

Faecal sludge is the waste accumulated in a septic tank which is a raw or partially digested mixture mostly of excreta and water. Faecal sludge management involves the collection, transportation, treatment and disposal of sludge from on-site sanitation systems in a safe manner.

Faecal Sludge

In rural areas, households rely on on-site sanitation systems and predominantly on twin pit systems which do not generate any faecal sludge. Some households, however, have septic tanks or single pit toilets, especially in densely populated or large peri-urban villages. The septic tanks and single pits partially treat black-water that is generated and hence need to be desludged and treated safely. Septic tank and single pits overflowing into storm water drains or pathways are prevalent in certain areas. Also, Greywater from household is discharged in the same drain flowing outside or nearby. Such drains ultimately end up in water bodies and pollute it.



Black water from Septic tank

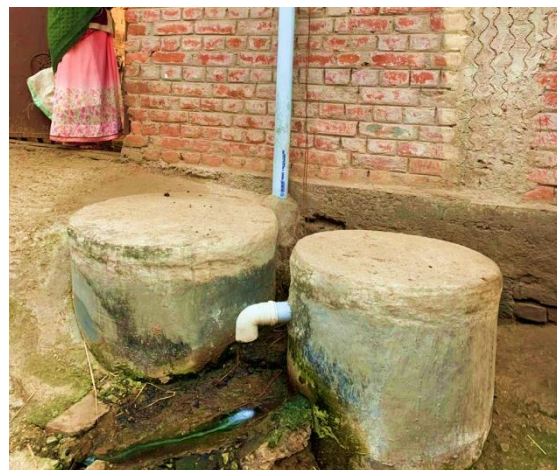

Black water from Single pit

WHY SHOULD WE PLAN AND TREAT FAECAL SLUDGE

- Septic tanks do not treat the sludge, single pits need to be left unused for many months to treat the sludge
- When a single pit/ Septic tank is full, the toilet may be blocked
- Overflows from filled-up septic tanks and indiscriminate disposal of faecal sludge cause the spread of diseases and environmental pollution
- Households do not know the *when-How* of desludging
- Vacuum trucks emptying septic tanks/single pits generally dispose of it in an unsafe manner in water bodies or the open outside the village

Faecal Sludge Characteristics

Parameters	Raw Sewage	Faecal Sludge
BOD (mg/l)	110 - 350	10000 - 36000
COD (mg/l)	250 - 800	25000 - 100000
TSS (mg/l)	120 - 400	10000 - 40000

Comparison of effluent parameters between raw sewage and faecal sludge is clearly indicating that the faecal sludge parameters are 100 times higher than the raw sewage, hence it needs to be treated properly.

Decision matrix for Faecal Sludge Management

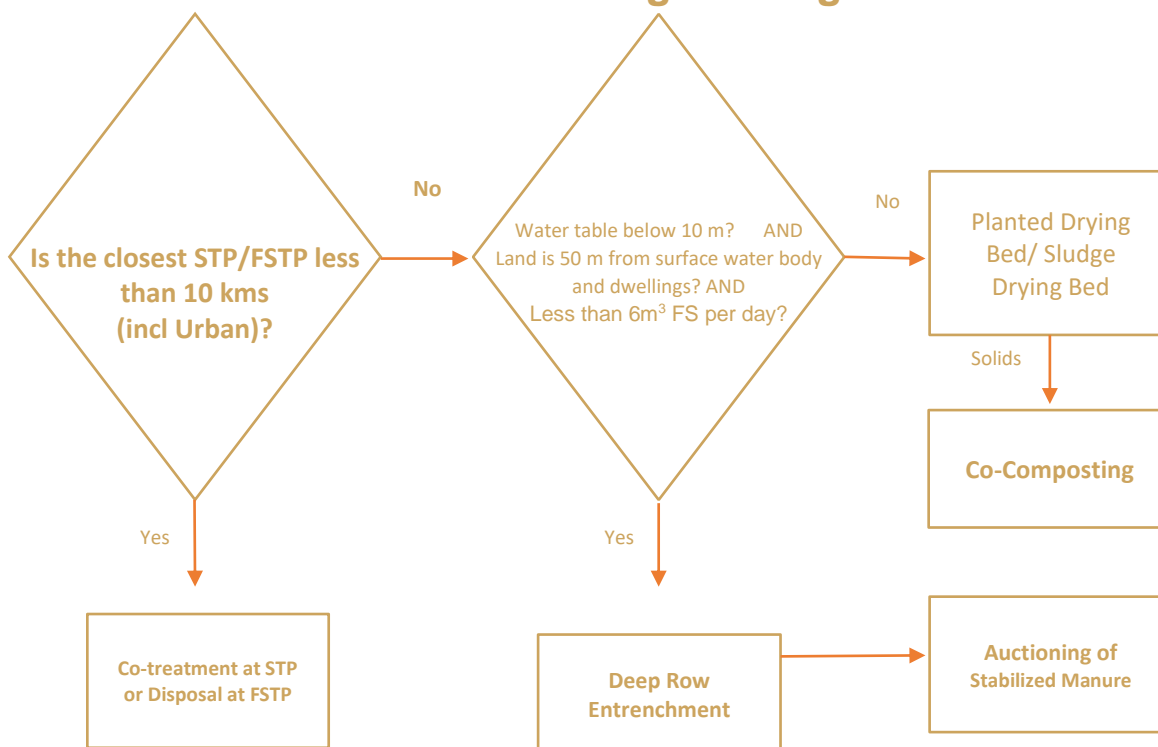

PLANNING AND IMPLEMENTATION OF FAECAL SLUDGE MANAGEMENT

Step 1– Retrofitting of existing toilets

- Know your pits and tanks – The district may prepare a list of households where septic tanks and single pits are constructed.
- Wherever Single pits are constructed, convert them to two pit toilets. Other options like vermi-filter toilet or toilet linked biogas plant can also be considered if space is available. Similarly, soak pits to be constructed for treating effluent from septic tanks.
- Plan desludging on regular intervals for areas with septic tanks. Any single pit toilets which have not been converted to twin pit may also need to be desludged

Step 2 – Locating existing STP and FSMPs

- The district must prepare an assessment of the number, capacity and location of existing Sewage Treatment Plants (STPs) and Faecal Sludge Management Plants (FSMPs) available in the District established under various Schemes of State and Central Government or by a private entity, in urban or rural areas.
- Basic proximity analysis of all STPs/FSMPs at the district level will reveal the number of villages that can be covered with a co-treatment option. This may be given the highest priority as it reduces the need for constructing a new Faecal Sludge Management Plant.

Step 3 - Co-treatment with existing infrastructure

- License the operations of all existing operators in the district and introduce regulations to all private operators
- Only mechanical desludging to be allowed, ensuring enforcement of The Prohibition of Employment as Manual Scavengers and their Rehabilitation Act, 2013 and provisions for penalizing defaulters.
- Enforce co-treatment of sludge collected from nearby villages

Safe emptying and transportation

- Use of safety gears should be ensured for emptying pits and Septic tanks
- List out the number of desludging trucks available and their services to be extended to rural areas. Build capacities and certify them. Villages/ GPs within a 15-20 km radius can be mapped for using the existing plant. The transport trucks should be leakage free.

- **Commonly used Emptying/desludging equipment :**

- Vacuum truck
- Tractor mounted vacuum
- Tanker
- Vacuum pump

- Ascertain spare capacity of the plant and coordinate with the appropriate authorities to dispose of faecal sludge in the existing STP or FSMP



Trucks used



Step 4:
PLAN A

FSTP IN THE DISTRICT

A new FSTP can be planned and implemented if co-treatment is not possible. The DWSC should plan to set up and ensure operation of systems for 100 per cent safe and sustainable collection, transportation, treatment and disposal of faecal sludge. Following steps need to be ensured:

1. Identify suitable land
2. Determine a cluster of villages to be served by the new FSTP based on distance and road access
3. Plan for a FSTP of appropriate capacity
4. Consult a technical agency/expert with minimum 3-5 years' experience in implementation of the FSM projects
5. Encourage entrepreneurs to operate business models for collection and treatment of waste
6. Identify markets for the sale of compost from the plant. Eg: local farmers, forest department, nearest municipality, highway authority etc.

SITE IDENTIFICATION FOR FSTP

The DWSC should ensure the following while identifying the location/site for FSTP :

- The site should have approach roads and easy to reach and should have sufficient space for sheds, rooms and parking of trucks/ vehicles containing sludge and other vehicles
- It should not be near to a water body
- Will not pose any challenge to the aesthetics and environment of the area
- Not near any densely populated area

TREATMENT TECHNOLOGY OPTIONS

The faecal sludge management can be taken up for a single large dense village (LDV) or a cluster of villages/GP through any one of the following interventions:

1. Deep row entrenchment (Trenches):

This option may be adopted for a cluster of villages where less quantity of faecal sludge is collected. This technology is not appropriate for villages close to water bodies (rivers, lakes and coastal areas) and also where the ground water level is high.



2. Unplanted Drying Bed

An unplanted drying bed is a simple technology which could be used in rural areas. The bed allows the water to percolate and sludge will remain at the top, which dries by evaporation. The percolated water or leachate will be collected at the bottom, where perforated pipes are laid. Approximately 50% to 80% of the sludge volume drains off as liquid or evaporates.



The bottom of the drying bed is lined with perforated pipes to drain the leachate away that percolates through the bed. On top of the pipes are layers of gravel and sand that support the sludge and allow the liquid to infiltrate and collect in the pipe. It should not be applied in layers that are too thick (maximum 20 cm), or the sludge will not dry effectively. The final moisture content after 10 to 15 days of drying should be approximately 60%. When the sludge is dried, it must be separated from the sand layer. This dried sludge can be used for agriculture purpose or for co-composting. The leachate that is collected in the drainage pipes must also be treated properly, depending on where it is discharged.

3. Planted Drying bed

A planted drying bed is like an unplanted drying bed but has the added benefit of transpiration and enhanced sludge treatment due to the plants. The key improvement of the planted bed over the unplanted bed is that the filters do not need to be desludged after each feeding/drying cycle. Fresh sludge can be directly applied to the previous layer; the plants and their root systems maintain the porosity of the filter.



This technology has the benefit of dewatering and stabilizing the sludge. Also, the roots of the plants create pathways through the thickening sludge that allow water to easily escape. The beds are filled with sand and gravel to support the vegetation. Instead of effluent, sludge is applied to the surface and the filtrate flows down through the subsurface where it is collected in drains.

Recommended activities for Swachhagrahis and incentive structure

Activities	Allowable payment of incentive
1. Facilitating sanitation coverage for all eligible households <ul style="list-style-type: none"> ○ Coverage of all eligible households in the spirit of No One Left Behind ○ Motivating new eligible households to construct toilets as per safe technology 	Up to Rs. 150 per toilet
2. Facilitating self-construction of toilets by new (not-eligible) families/ HHS	Rs. 25 per toilet
3. Raising community awareness on following for continued ODF sustainability behaviours. The activities will include door to door outreach (1 visit per fortnight), wall painting (2), sharing key messages using digital media (number of messages shared), distributing pamphlets/ posters etc (number of documents distributed). <ul style="list-style-type: none"> ○ Continued usage of toilet by all, at all times ○ Raising awareness and verification reg. cleanliness of toilets ○ Raising mother's awareness regarding safe disposal of child faeces 	Up to Rs. 15 per household per visit
4. Building Community awareness on the following to ensure public health and hygiene. The activities will include door to door outreach, wall painting, sharing key messages using digital media, distributing pamphlets/ posters etc. in a campaign mode: <ul style="list-style-type: none"> ○ Hand washing with soap at regular intervals and at critical times ○ Safe storage of drinking water ○ Maintaining coughing/ sneezing hygiene (wearing masks, covering face etc.) ○ Maintaining social distancing 	Up to Rs. 500 per village per month for the campaign period
5. Ensuring that Community Sanitary Complexes (CSCs) are constructed in the village <ul style="list-style-type: none"> ○ Location of CSC at the recommended sites ○ Construction as per approved design (for design other than recommended by DDWS, the design approved by the State Govt. may be used) ○ Branding of CSC, including name of beneficiaries covered [if constructed for the households situated in the village(s)] 	Rs. 150 per CSC
6. Ensuring that GPs provide for O&M arrangements of the CSCs <ul style="list-style-type: none"> ○ Constitution of maintenance committee/ body ○ Allocation of O&M task to the above ○ Provision of funding for O&M 	Rs. 50 per CSC
7. Geotagging of toilets in the village	Up to Rs. 5 per toilet
8. Second verification and subsequent sustainability verification(s) of each household along with IPC/ IEC activity to ensure community awareness and participation leading to ODF (S) sustenance	Up to Rs. 15 per household (verification and IPC)

Activities	Allowable payment of incentive
9. Ensuring conversion of household's dysfunctional toilet to functional toilet <ul style="list-style-type: none"> ○ Repair of broken pan ○ Choked pipes ○ Blocked drains ○ Broken doors/walls/roof etc. 	Rs. 25 per toilet
10. Ensuring retrofitting of previously constructed toilets (as per safe technology) <ul style="list-style-type: none"> ○ Addition of a second pit to a single pit toilet ○ Construction of soak pit with septic tank ○ Construction of separate pits for in situ toilets etc. 	Rs. 25 per toilet
11. Ensuring following SLWM activities in the village and creating public awareness on the operation and maintenance of the assets created <ul style="list-style-type: none"> ○ Construction of pucca and covered drains (one time) ○ Construction of community soak pits (one time) ○ Construction of community compost pits (one time) ○ Construction of individual/ community bio gas plants 	Rs. 200 per village (assuming the village will comprise of 50-100 households)
12. Ensuring activities for visual cleanliness in the village <ul style="list-style-type: none"> ○ Maintenance of drains (monthly) ○ Maintenance of bio gas plants (monthly) ○ Cleaning of ponds, drains, streets, local markets, etc. - fortnightly. ○ Early morning/evening Nigrani, along with the other Nigrani Samiti members - weekly. ○ Organizing Ratri chaupals/ village meeting on the issue of Swachhata/ ODF sustainability- monthly 	Rs. 200 per village (assuming the village will comprise of 50-100 households) per activity
13. Facilitating ODF sustainability activities <ul style="list-style-type: none"> ○ Repair and cleanliness of toilets in institutional buildings and CSCs on monthly basis. ○ Observance of days of national importance viz. Independence Day, Republic day as well as ODF day/ Swachhata day to commemorate the ODF status of the village. ○ Construction (one time) and maintenance (monthly) of Model Toilet at GP level ○ ODF branding in the village- wall writings, erection of display board/plaque announcing the ODF status of the village ○ Passing of resolution in the Gram Sabha for the following: <ul style="list-style-type: none"> ○ ODF declaration of the village ○ ODF verification of the village ○ Post-ODF declaration, any new families/ HHs to essentially self-construct their toilet 	Rs. 200 per village (assuming the village will comprise of 50-100 households) per activity

Such initiatives may only be provided to Swachhagrahis (non-government employees) with demonstrated skills and requisite capacity (successful completion of 5 days CAS training and other mandatory trainings as recommended by Gol) for carrying out the above activities, to be certified at the district level.

Non-financial incentives

These include recognition by Governments at different levels. They are felicitated by different public and private organisations (e.g. recognition/awards by Government etc.). Some creative rewards have also been introduced in different States and districts, such as Lunch and Dinner of Champion Swachhagrahis with the District Collector. Some States also choose to give incentives such as passes/ discount for travel through public transport/ train; provision of insurance (medical and / or life insurance); Atal Pension Scheme, etc.

Indicative list of sanitation activities and suggestive convergence matrix

Components	Source of funding				
	SBM Ph-II funds (Centre+ State)	15 FC funds	MG-NREGS	Business model / CSR	Beneficiary contribution
A. Village level activities					
IHHLs	✓				
Retrofitting		✓			
CSCs	✓	✓			
O&M for CSCs		✓		✓	
Solid Waste Management					
Segregation Bins at households		✓			
Segregation Bins at Public Places		✓			
Compost Pits, Tri-cycles/other vehicles, Storage for Plastic Waste	✓	✓	✓		
Setting up of segregation, storage and compost premises			✓		
Wages for collection and segregation		✓			
Equipments for cleaning the premises and segregation of waste		✓			
O&M for Solid Waste Management				✓	
Greywater Management					
Soak pits	✓	✓	✓		
Greywater Management systems (WSP etc.)	✓	✓	✓		
Aeration of big ponds				✓	
Drainage channels		✓	✓		
O&M for Greywater Management				✓	
Menstrual waste management (Incinerators-CPCB/SPCB approved) - Block level		✓			

Components	Source of funding				
	SBM Ph-II funds (Centre+ State)	15 FC funds	MG-NREGS	Business model / CSR	Beneficiary contribution
B. District/Block level activities					
Plastic Waste Management					
Plastic Waste Management Units (PWMU)	✓				
Transportation from village storage point to PWMU including vehicle				✓	
O&M for Plastic Waste Management Unit				✓	
Faecal Sludge Management					
Trenching	✓				
Faecal Sludge Management Plant					
Co-treatment	Convergence with nearby STPs/FSTP.				
Mechanised Emptying and transportation of faecal matter from Septic tanks/single pits				✓	
O&M for Faecal Sludge Management				✓	
GOBAR-Dhan Projects					
GOBAR-dhan model projects	✓				
Scaling up of GOBAR-Dhan projects (minimum 10 per Block) on the lines of financial assistance under NNBOBP of MNRE		✓			✓
O&M for GOBAR-Dhan Projects				✓	

Note: The above suggested convergence matrix is subject to the specific funding provisions for some components as given in these guidelines.

AUDIT REPORT

[Consolidated Audit Report for SBMG]

Containing following points (documents):

1. Auditor's Report
2. Receipt and Payment Account
3. Income and Expenditure Account
4. Balance sheet
5. Notes Forming Part of Accounts (Reporting about physical output)
6. Auditor's observations as 'Annex'

(In case of any observation, reply countersigned by Chartered Accountant is required)

7. Letter issued by O/o CAG in support of empanelment of the Chartered Accounts for the financial year 202*-** (year in which the CA conducts audit of the account)

Signature_____

Name in full_____

Office Stamp of competent authority of SWSM

Dated_____

N.B: All the documents should be in original and countersigned by Competent Authority of SWSM with official stamp.

AUDITOR'S REPORT

To

The State Swachh Bharat Mission
Address

1. We have audited the attached 'Balance Sheet' of State Water and Sanitation Mission ('the Grantee') "Account – Swachh Bharat Mission (Grameen) (SBMG)" as on March 31, 20** and also the 'Income and Expenditure Account' and 'Receipts and Payment Account' for the year ended on that date annexed thereto. These financial statements are the responsibility of the Grantee's management. Our responsibility is to express an opinion on these financial statements based on our audit.

2. We conducted our audit in accordance with auditing standards generally accepted in India. Those Standards require that we plan and perform the audit to obtain reasonable assurance about whether the financial statements are free of material misstatement. An audit includes examining, on a test basis, evidence supporting the amounts and disclosures in the financial statements. An audit also includes assessing the accounting principles used and significant estimates made by management, as well as evaluating the overall financial statement presentation. We believe that our audit provides a reasonable basis for our opinion.

3. Further to our comments in the Annexure referred to above, we report that:

- i. We have obtained all the information and explanations, which to the best of our knowledge and belief were necessary for the purposes of our audit;
- ii. In our opinion, proper books of account as required, have been kept by the Grantee so far as appears from our examination of those books;
- iii. The balance sheet, income and expenditure account and receipts and payment account dealt with by this report are in agreement with the books of account;
- iv. In our opinion, and to the best of our knowledge and according to the explanations given to us and subject to our observations annexed herewith we report that:
 - a. The Balance Sheet, gives a true and correct view of the State and affairs of the Grantee "Account – Swachh Bharat Mission (Grameen) (SBMG)" as on 31.3.202*.
 - b. The Income and Expenditure Account gives a true and correct view of excess of income over expenditure/excess of expenditure over income for the period ended 31.03.202*.

- c. The receipts and Payment Account gives a true and correct view of the transactions under the programme/scheme for the period ended on 31.03.202*.
- iv. Expenditure reported in the Income and Expenditure account is properly reflected in the Utilization Certificate(s) for the same period.

Signature of Chartered Accountant with Seal)

Name in full_____

Membership No._____

CAG Empanelment No. and Year

Contact No.

E-mail ID:

ANNEXURE – IX(C)

Audit Report for the year _____

State Swachh Bharat Mission (Grameen) (Name of State)

Receipt and Payment Accounts for the period 1st April, _____ to 31st March, _____

Name of the scheme - Swachh Bharat Mission (Grameen) (SBMG)

(Rs.in lakhs)

Receipt	Amount	Payment	Amount
1. Opening Balance (i) Cash in Hand (ii) Cash at Bank (iii) Deposits at Division/Districts etc.		1. Advances given to (i) Implementing Agencies (ii) Any other agencies etc.	
2. Receipt of Grants (i) Central Government (ii) State Government (iii) Other agencies		2. Expenditure incurred for the purpose of approved work undertaken under (SBMG): i) IHHL ii) CSC iii) SLWM iv) IEC v) Capacity strengthening (training, etc)	
3. Interest received from Banks (i) SWSM level (ii) DWSM/DWSC level (iii) Others		3. Expenses on Administration a. Staff support services b. Monitoring and Evaluation c. Printing and Stationery d. Bank Charges e. Rent and Taxes f. Audit Fees g. Miscellaneous Expenses etc.	
4. Refund of Advance/ Loan/Grant from (i) Implementing Agencies (ii) Any other agencies etc.			
5. Miscellaneous Receipts		5. Closing Balance (i) Cash in Hand (ii) Cash at Bank (iii) Deposits at Division/Districts etc.	

Signature of Competent Authority

Name in full:

Office seal

Contact No.

E-mail ID:

(Signature of Chartered Accountant with Seal)

Name in full:

Membership No. _____

CAG Empanelment No. and Year

Contact No.

E-mail ID:

ANNEXURE – IX(D)

Audit Report for the year _____

State Swachh Bharat Mission (Grameen) (Name of State)

Income and Expenditure Accounts for the period 1st April, _____ to 31st March,

_____ Name of the Scheme - Swachh Bharat Mission (Grameen) (SBMG)

(Rs. in lakhs)

Expenditure	Amount	Income	Amount
1.Expenditure incurred for the purpose of approved work undertaken under (SBMG): i. IHHL ii. CSC iii. SLWM v. IEC vi. Capacity strengthening (training etc.)		1.Grants -in -Aid/ Subsidy received from: (a) Central Govt. (b) State Govt. (c) Other Agencies	
2. Expenses on Administration a. Staff support services b. Monitoring and Evaluation c. Printing and Stationery d. Bank Charges e. Rent and Taxes f. Audit Fees g. Miscellaneous Expenses etc.		2. Interest received during the year from the Bank Accounts - Received during the year - Add: Accrued during the year - Less: related to previous year	
3. Excess of Income over Expenditure carried over to Balance Sheet		3. Refund of unutilized grants by the Implementing Agencies	
		4. Miscellaneous Receipts	
		5. Excess Expenditure carried over to Balance Sheet	

Signature of Competent Authority
Name in full
Office seal
Contact No.
E-mail ID:

(Signature of Chartered Accountant with Seal)
Name in full:
Membership No.
CAG Empanelment No. and Year
Contact No.
E-mail ID:

ANNEXURE – IX(E)

Audit Report for the year _____

State Swachh Bharat Mission (Grameen) (Name of State)

Balance Sheet as on 31st March, _____

Name of the scheme - Swachh Bharat Mission (Grameen) (SBMG)

(Rs. in lakhs)

CAPITAL FUND AND LIABILITIES	Previous Year Amount	Current Year Amount
Accumulated Fund		
Opening Balance		
Add/Deduct:		
Balance Transferred From Income and Expenditure Account		
Current Liabilities		
(i) Outstanding Expenses/Payables		
(ii) Any other Liability		
Total		
ASSETS		
Fixed Assets		
(i) Vehicles		
(ii) Furniture and fixtures		
(iii) Office Equipment		
(iv) Computers and Peripherals		
(v) Others etc.		
Current Assets and advances		
(i) Stock		
(ii) Temporary Transfer of Funds to other schemes recoverable		
(iii) Closing Balance		
(a) Cash in Hand		
(b) Cash at Bank		
(c) Amount Receivables and Advances recoverable		
(i) Implementing Agencies		
(ii) Other Agencies		
(iii) Staff		
(iv) Suppliers etc.		
Total		

Signature of Competent Authority

Name in full

Office seal

Contact No.

E-mail ID:

(Signature of Chartered Accountant with Seal)

Name in full:

Membership No.

CAG Empanelment No. and Year

Contact No.

E-mail ID:

ANNEXURE – IX(F)

Notes Forming part of the Accounts

Physical output under State Swachh Bharat Mission (Grameen)(SSBMG) for the utilized funds as reported in the Income and Expenditure Account:

Components	Performance/Number of units constructed during the year
I. Individual Household Latrines – BPL/APL II. Community Sanitary complexes III. Solid Waste Management (SWM) activities at villages a. Community compost pits b. Storage for plastic c. Tricycles/vehicles for collection of waste IV. Greywater management activities a. Community soak pits b. Greywater treatment systems (WSP/DEWATS, etc) V. Plastic Waste Management Units VI. Faecal Sludge Management activities VII. GOBAR-dhan projects	

Signature of Competent Authority
Name in full
Office seal
Contact No.
E-mail ID:

(Signature of Chartered Accountant with Seal)
Name in full:
Membership No.
CAG Empanelment No. and Year
Contact No.
E-mail ID:

AUDITOR'S OBSERVATIONS

Swachh Bharat Mission (Grameen) (Name of State)

Year _____

NAME OF THE ORGANISATION RECEIVING GRANTS:

SL. NO.	ISSUES	OBSERVATIONS OF THE AUDITOR
1	Opening Balance and Closing Balance of the Receipts and Payments account tallies with that of Cash Book.	
2	Opening Balance adopted tallies with Closing Balance of the last year	
3	Whether grantee or other implementing agencies have diverted / inter-transferred funds from one scheme to another Central Scheme or State funded Scheme during the period in contravention to the existing guidelines? If so details thereof.	
4	Are there any mis-utilisation/unrelated expenditure and mis-appropriation of funds by the grantee or other implementing agencies during the year? If so details thereof.	
5	There is only prescribed number of bank accounts for the scheme	
6	There does not exist any minus balance at any stage during the year	
7	If the Sanction Order of the Ministry specifies certain conditions at the time of release of funds, whether the same has been fulfilled.	
8	Scheme funds are being kept only in savings account	
9	Interest earned has been added to the scheme fund	
10	Whether interest money is being utilized strictly for the programme purposes as laid down in the existing guidelines	
11	State share, as per programme guidelines, for the year has been received within the stipulated timeline as per Guidelines	
12	All receipts / refunds have been correctly accounted for and remitted in to the Bank account of the scheme	
13	Scheme funds (in full or part) are not being kept in the State Treasury	
14	Bank Reconciliation is being done regularly	
15	Audit observation on compliance by SBMG implementing agencies of State Delegation of Financial Power Rules issued by the respective State Department of Finance and/or General Financial Rules (GFR) of Government of India and subsequent Government orders (as applicable)	
16	Name and address of the previous Auditor	

Signature of Competent Authority

Name in full

Office seal

Contact No.

E-mail ID:

(Signature of Chartered Accountant with Seal)

Name in full:

Membership No.

CAG Empanelment No. and Year

Contact No.

E-mail ID:

Utilization Certificate

State Swachh Bharat Mission (Grameen)(Name of State)
(Central Share / State Share)

Reference No.:

Date:

Sl. No.	Letter No. and date	Amount	
			Certified that out of Rs..... of grants-in-aid sanctioned during the year in favour of State Swachh Bharat Mission (Grameen)(Name of State_____) vide Department of Drinking Water and Sanitation, Government of India letter(s) No. given in the margin and Rs..... on account of unspent balance of the previous year, a sum of Rs. has been utilized for the purpose of approved work undertaken under Swachh Bharat Mission (Grameen) , for which it was sanctioned and that the balance of Rs..... remaining unutilized at the end of the year shall be carried forward to the next year for implementation of the programme.

2. Physical Output for the above utilized funds

Components	Performance/Number of Units constructed
Individual Household Latrines – BPL	
Individual Household Latrines – Identified APL	
Individual Household Latrines – Total APL (including identified APL)	
Community Sanitary complex	
Solid Waste Management activities in villages <ul style="list-style-type: none"> - Community compost pits - Storage for plastic - Tricycles/vehicles for collection of waste 	
Greywater Management activities in villages <ul style="list-style-type: none"> - Community soak pits - Greywater treatment systems (WSP/DEWATS etc.) 	
Plastic Waste Management Units	
Faecal Sludge Management <ul style="list-style-type: none"> - Trenching - FSM Plants 	
GOBAR-dhan projects	

3. Certified that I have satisfied myself that the conditions on which the grants-in-aid was sanctioned have been duly fulfilled / are being fulfilled and that I have exercised the

following checks to see that the money was actually utilized for the purpose for which it was sanctioned.

Kinds of checks exercised

- 1. Audited Statement of Accounts of SSBMG
- 2. Audited Statement of Accounts of DSBMGs
- 3. Previous Utilisation Certificates
- 4. Physical Verification Reports
- 5. Review Mission Reports
- 6. *Any other document/check*

Countersigned by Mission Director (SBMG)

Signature
Name
Designation
(Principal Secretary /Secretary in-charge of Rural Sanitation)
Date
(affix official seal)

Swachh Bharat Mission (Grameen) Gram Panchayat ODF Plus Certificate



I, _____, Sarpanch/Up-Sarpanch/Pradhan/Mukhiya of _____ Gram Panchayat, _____ District, _____ State, and I, _____, the Panchayat Secretary, hereby certify that our Gram Panchayat is now ODF-Plus (Open Defecation Free with solid and liquid waste management). This resolution was adopted during the Gram Sabha held on _____.

Signature of
Sarpanch/Pradhan/Mukhiya

Signature of Panchayat Secretary

Name

Name

Official Seal

Official Seal

ODF Plus verification protocol

TIMELINE FOR VERIFICATION

The process of ODF Plus verification will start with the Gram Sabha resolution of self-declaration of achievement of ODF Plus status. The verification process would be carried out after three months (90 days) of the declaration to verify the ODF Plus status. The unit of verification would be revenue village. The districts should complete their verification as the villages are declared and should not wait for all the villages of Gram panchayat or Block to be declared as ODF Plus.

The verification of the village by the verification team should be completed in 2 days' time. The indicators defined in the definition of ODF Plus must be captured in the survey. In case there are gaps identified and the ODF Plus status of the village is not confirmed in the verification, villages would be given a months' time (30 days), from the date of initiating the verification exercise, to plug in the identified gaps. In such cases the final verification of the villages would be carried out after 30 days of the previous verification.

The verification of ODF Plus shall be an annual exercise, starting from when the village is declared ODF Plus.

CONSTITUTION OF THE VERIFICATION TEAM

The District Collector would constitute a team of 4 People for each Block in the district, which would include a District level officer and three Block level officers⁵. Verification of the ODF Plus claims of all villages would be done by Inter-Block Teams. The verifying teams will have to be appropriately trained to understand ODF Plus definition and its components to be verified. After satisfactory verification, verification team should submit a signed certificate of verification confirming the ODF Plus status of the village to the District Nodal Officer.

The District SBM Coordinator/District Development Officer / Director, District Rural Development Agency/ District Panchayati raj Officer as complying with the Govt. Of India guidelines, would be appointed as District nodal officer for reporting and entering of ODF Plus verified villages. The nodal officer should ensure entering of ODF Plus verified village in SBM IMIS not later than 5 days after receiving certificate of verification confirming the ODF Plus status of the village.

SELECTION OF PUBLIC INSTITUTIONS

Each public institution (School, AWC and Panchayat Ghar) is to be verified. In case of more than one school and AWC in a village, Team should select the facility which is catering to a greater number of children.

⁵This may include BDO, Block coordinator SBM, Swachhagrahi, Headmaster, ADO panchayat, Block education officer, Block agriculture officer, etc.

ANNEXURE XII (B)

ODF PLUS VERIFICATION FORMAT

#	Parameter	Checklist
1	All households in the village have access to a functional toilet facility (own/shared/community)	Yes/No
2	At least one functional community sanitary complex (CSC) is present in the village, with separate toilets for male and female	Yes/No
3	All schools/Anganwadi Centres(AWC)/Panchayat Ghar in the village have access to a functional toilet, with separate toilets for male and female (In case of no toilet in AWC, all the children of AWC must have access to nearby public toilet/ school toilet/ own house)	Yes/No
4	All public places in the village have: <ul style="list-style-type: none"> ● Minimal litter ● Minimal stagnant wastewater ● No plastic waste dump 	Yes/No
5	At least 80% households, and all schools, Anganwadis, panchayat Ghar have arrangement for managing biodegradable waste through: <ul style="list-style-type: none"> ○ Community / HH Compost pits ○ Community / HH Bio-gas plants ○ Any other mechanism 	Yes/No
6	At least 80% households, and all schools, Anganwadis, panchayat Ghar have arrangement for managing liquid waste through: <ul style="list-style-type: none"> ○ Community Soak pits ○ Individual Soak pits ○ Waste stabilization ponds ○ Any other mechanism 	Yes/No
7	The village has a plastic segregation and collection system	Yes/No
8	At least 5 ODF-Plus IEC messages put up in the village at prominent public places pertaining to: <ul style="list-style-type: none"> ○ ODFS ○ SLWM ○ Key Hygienic Practices 	Yes/No

Swachh Bharat Mission (Grameen)
District ODF-Plus Certificate



I, _____, District Collector of _____ District,
_____ State, hereby certify on behalf of citizens and
administration of _____ District that our District is
ODF-Plus (Open Defecation Free with solid and liquid
waste management), as on _____.

Signature

Name

Official Seal.....Designation

Diversion of forest land for non-forestry purposes – Guidelines for construction of community toilet for the benefit of the people

F. No. 11-09/1998-FC (Pt.)
Government of India
Ministry of Environment, Forests & Climate Change
(Forest Conservation Division)

Indira Paryavaran Bhawan,
Jor Bagh Raod, Aliganj,
New Delhi: 1100 03,
Dated: 8th November, 2016.

To

The Principal Secretary /Secretary (Forests),
All State / UT Governments.

Sub.: Diversion of forest land for non-forestry purposes under Forest (Conservation) Act, 1980 – Guidelines for construction of community toilet for the benefit of the people-reg.

Ministry of Environment & Forests at New Delhi has received proposals from Maharashtra, seeking general approval of the Central Government under Section-2 of the Forest (Conservation) Act, 1980 for diversion of forest land for construction of community toilet in rural and urban areas under *Swachh Bharat Abhiyan* of the Government of India which involve wholly or partly the forest land for the benefit of the people.

The Ministry has examined the issue of granting general approval to the State Government under section 2(ii) of Forest Conservation Act 1980 for construction of government approved community toilet involving forest land up to 1.00 ha.

I am directed to convey the general approval of Central Government under section 2(ii) of F C Act 1980 granted for construction of government approved community toilets on land involving partly or fully the forest lands (Government, private and deemed and other forests) not exceeding 1.00 ha of forest land subject to approval of gram panchayat in rural areas and urban local body in urban areas to utilise the forest land on the following condition.

The general approval shall be subject to fulfilment of following conditions.

1. The forest land to be diverted for community toilet should be less than one hectare in each case.
2. The clearance shall be subject to the condition that the same is need based. The concerned Divisional Forest Officer shall assess the bare minimum requirement of the forest land for the project, which shall not exceed one hectare in each case and will also certify to this effect.
3. The legal status of the land shall remain unchanged i.e., shall remain Reserved / Protected / Village / Un-classed other types of forests/forest as the case may be.

02/11/16

1

4. The User Agency shall submit the project proposal to the State/UT Government in the prescribed format online with DGPS coordinates of each individual community toilet to be constructed
5. The project should not involve felling of more than fifty (50) trees per hectare. Corresponding permissible limit of maximum number of trees to be felled for the forest area diverted, shall be in proportion to the extent of the diverted area.
6. The concerned Divisional Forest Officer shall assess the bare minimum requirement of the forest land for the project, which shall not exceed one hectare in each case and will also certify to this effect.
7. The User Agency will seek permission for diversion of forest land duly recommended by Principal Chief Conservator of Forests, from the State/UT Government.
8. The Nodal Officer (Forest Conservation) shall submit monthly report to the concerned Regional Office by 5th of every month regularly regarding approval of such cases. In the event of failure, the exercise of power by the State/UT Government to grant such permission may be suspended by the Central Government for a specified period of time or till the information is submitted.
9. The User Agency shall plant and maintain two times the number of trees felled on the diverted land to maintain the green cover at the project cost. Planting site for the purpose will be identified by the State Forest Department (preferably within or in the surrounding area of the project). Only indigenous forest tree species shall be used for such plantations. Trees, if planted on the diverted area, will not be felled without the permission of the State Forest Department. Trees, planted in surrounding area, will belong to State Forest Department.
10. The compensatory levies such as NPV and Compensatory Afforestation cost (at least **1000 plants per ha or 10 times the tree to be felled, whichever is greater** to be planted in the degraded forest identified by the Forest Department) and other charges as specified in FC approval letter shall be borne by the authority who applies for diversion under FC Act.
11. The User Agency shall be responsible for any loss to the flora and fauna in the surroundings and therefore shall take all possible measures to conserve the same.
12. The permission granted by the State Government shall be subject to the monitoring by the concerned Regional Office of the Ministry of Environment and Forests.
13. The forest land shall not be used for any purpose other than that specified in the proposal. Any change in the land use without prior permission of the Central Government shall amount to the violation of Forest (Conservation) Act, 1980.
14. The forest land shall not be used for any purpose other than that specified in the proposal. Any change in the land use without prior permission of the Central Government shall amount to the violation of Forest (Conservation) Act, 1980. Request for such changes shall be made to the Regional Officer by the Nodal Officer (Forest Conservation) of the State/UT.

Handwritten signature and date: 08/10/16

15. The State Forest Department, State Government, or the concerned Regional Office may impose from time to time any other condition in the interest of conservation, protection and or development of Forests.

It may also be noted that this general approval under Section-2 of Forest (Conservation) Act, 1980 is subject to the NOC issued by competent authority under the Scheduled Tribes and Other Traditional Forest Dwellers (Recognition of Forest Rights) Act, 2006.

The general prior approval is not extended to forest land in National Parks and Wildlife Sanctuaries and other protected areas under Wildlife Protection Act 1972.

Since the community toilet will be required in several locations within the administrative control of the government and urban local body, separate application under FC Act will require lot of paper work therefore the competent authority in Government/ Urban local bodies may get approval of all proposed community toilets, each not exceeding 1.00 ha at a place, as per plan and duly approved by the competent authority in Government by applying online collectively specifying the location, lay out plan and area in each case as per the procedure prescribed under Forest Conservation Rules and guidelines issued from time to time by MoEF & CC. Once the forest clearance is granted by the state under general approval under section 2(ii) of FC Act, the community toilet may be developed by agencies involved in construction and maintenance of community toilet to whom the competent authority in Government/ Urban local bodies may assign.

However the general prior approval under section 2(ii) of FC Act 1980 for construction of community toilet granted to the state government by this circular may be further delegated by the state government to officer in the Forest Department not below the rank of the Nodal officer (Forest Conservation), for granting approval under section 2(ii).

This issues with the approval of the competent authority.

Yours Faithfully,



(Rajagopal Prashant)

Sr. Assistant Inspector General of Forests (FC)





पेयजल एवं स्वच्छता विभाग
जल शक्ति मंत्रालय
भारत सरकार

DEPARTMENT OF DRINKING WATER AND SANITATION
MINISTRY OF JAL SHAKTI
GOVERNMENT OF INDIA

सत्यमेव जयते

